

F800RA he-dynamic

lbs/ft

F800RA he-dynamic



CRANES WITHOUT COMPROMISE

US

F800RA he-dynamic

LIFTING CAPACITY:

up to 522006 lbs.ft

MAX OUTREACH:

up to 99'10" ft with jib

OVERALL DIMENSIONS:

15'0" ft, w 8'2" ft, h 8'1" ft

ELECTRONIC/HYDRAULIC EQUIPMENT

IMC integral machine control

FX800 control unit

D900 digital distributor bank

RCH/RCS radio remote control unit

ADC automatic dynamic control

flow sharing

CHARACTERISTICS:

he-dynamic version (.2): with linkage

XP device

ProLink system with double linkage

continuous rotation on a slew ring

FR

F800RA he-dynamic

CAPACITÉ DE LEVAGE:

jusqu'à 522006 lbs.ft

BRAS HYDRAULIQUE:

jusqu'à 99'10" ft avec jib

ENCOMBREMENT GRUE:

15'0" ft, w 8'2" ft, h 8'1" ft

ÉQUIPEMENT ÉLECTRONIQUE/HYDRAULIQUE:

système de contrôle intégral IMC

unité de contrôle FX800

distributeur hydraulique digital D900

unité de commande radio RCH/RCS

contrôle de la dynamique ADC

flow sharing

CARACTÉRISTIQUES:

version dynamic (.2): avec bielle

dispositif XP

système ProLink avec double bielle

rotation continue sur couronne dentée

ES

F800RA he-dynamic

POTENCIA DE ELEVACIÓN:

hasta 72,17 tm

MÁXIMO ALCANCE HIDRÁULICO:

hasta 99'10" ft con jib

EMBARAZADO GRÚA:

15'0" ft, w 8'2" ft, h 8'1" ft

DOTACIÓN ELECTRÓNICA/HIDRÁULICA:

sistema de control integral IMC

unidad de control FX800

distribuidor hidráulico digital D900

unidad de mando radio RCH/RCS

dispositivo control dinámico ADC

flow sharing

CARACTERÍSTICAS:

versión dynamic (.2): con sistema de bielas

dispositivo XP

sistema ProLink y doble mecanismo a biela

rotación continua sobre corona

The images are sole purpose of presentation of the product - Les images sont à seule fin de la présentation du produit - Las imágenes son solo propósito de la presentación del producto



The images are sole purpose of presentation of the product - Les images sont à seule fin de la présentation du produit - Las imágenes son solo propósito de la presentación del producto



F800
Gallery







US CONTINUOUS ROTATION

Continuous rotation with double roller and ball guide turntable and motoreductor.

FR ROTATION CONTINUE

Rotation continue sur couronne dentée à double guidage par roulements avec motoréducteur.

ES ROTACIÓN CONTINUA

Rotación continua en chumacera de doble circulación de bolas con motorreductor.

F800RA he-dynamic

Crane belonging to the HC1S2 class (if installed on truck) according to EN 12999:2011 - Grue appartenant à la classe HC1S2 (s'il est installé sur le camion) selon la norme EN 12999:2011 - Grúa que pertenezca a la clase HC1S2 (si está instalado en el camión), de acuerdo con la norma EN 12999:2011

US

Features

BASE - Base with slots for tie rod fastening or for integrated counterframe allowing limitation of fitting height. Base is available on request also in "LP" version (Low Profile) for integrated subframe to restrict the height of the set-up.

BOOMS GUIDE - Extension booms guide shoes with "forced" assembly to reduce vertical and horizontal clearance, ensuring greater durability and adjustable lateral guide shoes. Special guide shoes material with high sliding degree and low greasing request.

TANK - Plastic tank, particularly resistant to shocks and the corrosive action of any external element.

OUTRIGGER - Hydraulically extendable outriggers with jointed outrigger rams plate in monocast material. Hoses fitted inside the stabiliser supports. Independent hydraulic distributor for the control of the outriggers; it can be also activated by radio control. Available as option hydraulic tiltable outriggers.

Optional

WORKLIGHT - Powerful and versatile light that can be directed as required: helps you to work safely, even in conditions of poor natural light. Can be activated by means of the radio remote control pushbuttons.

JIB - Additional hydraulic articulation to increase the reach and to move loads horizontally at different heights (without preventing to fold the crane in its natural rest position). Exclusive Fassi Prolink system allowing to increase the working angle of the jib by 20 degrees (10 degrees L21) above the horizontal line.

SEAT - Ergonomic, protected position to allow the operator greater control when carrying out specific movement and lifting operations. There are many possibilities of adjustments to find out the most comfortable working and control position and heated top seat as option.

SUPPLEMENTARY FUNCTIONS - Supplementary functions for the use of hydraulic accessories on the crane and the jib, protected by an exclusive Fassi system consisting of metal trays paired with highly resistant nylon guide-chains. High quality hoses resistant to the ozone action.

WINCH - Cable-operated lifting device equipped with an exclusive, patented mechanical, torque and end stop limiter system which avoids the risks resulting from direct and indirect overload applied to the winch itself. Anti-revolving cable and cable guide pulley to make easy the aligned winding of the cable on the winch drum.

FR

Caractéristiques

EMBASE - Embase avec oreilles de fixation et tirants ou par faux-châssis intégré limitant de la hauteur de l'installation. Disponible aussi, sur demande, en version LP (Low Profile) pour faux-châssis intégré, avec hauteur réduite.

PATINS DE GUIDAGE - Patins de guidage sur les bras d'extension, à montage "forcé" afin de réduire les jeux verticaux et latéraux prolongeant la durée de vie et patins latéraux réglables. Patins en matériel spécial avec un degré de glissement élevé et demande réduite d'engraissage.

RÉSERVOIR - Réservoir en matière plastique très résistant aux chocs et à l'action corrosive de tout élément extérieur.

STABILISATEURS - Stabilisateurs à extension hydraulique avec plat vérin stabilisateurs pivotant et plaques d'appui en Monocast. Tuyauteries à l'intérieur du support des stabilisateurs. Distributeur hydraulique dédié pour commande manuelle ou radio des stabilisateurs. Disponibilité comme option des stabilisateurs pivotants hydrauliquement.

En option

PHARE DE TRAVAIL - Phare directionnel variable, puissant et adaptable, qui permet de travailler en toute sécurité même avec une mauvaise visibilité. Peut être activé avec les boutons de la radiocommande.

JIB - Articulation hydraulique supplémentaire permettant d'augmenter l'extension de la grue et, une fois la hauteur désirée atteinte, de déplacer la charge horizontalement par rapport au sol (sans intervenir sur la configuration initiale de la grue au repos). Système Prolink Fassi exclusif augmentant l'angle de travail des rallonges hydrauliques de 20 degrés (10 degrés L21) au-dessus de la ligne horizontale.

SIÈGE - Poste ergonomique et protégé qui permet à l'opérateur un contrôle optimal lors d'opérations de déplacement et de levage spécifiques. Position de travail et des commandes réglable et option siège réchauffé.

TUYAUTERIES SUPPLÉMENTAIRES - Tuyauteries supplémentaires pour l'utilisation d'accessoires hydrauliques, sur grues et sur rallonges hydrauliques, protégées par un système exclusif Fassi se composant de supports en métal couplés à des chaînes de guidage en nylon à haute résistance. Tuyauteries flexibles de grande qualité résistantes à l'ozone.

TREUIL - Dispositif de levage par câble équipé du système exclusif breveté de limiteur de couple et de fin de course mécanique, évitant les risques de toute surcharge directe ou indirecte infligée au treuil. Câble anti-giratoire et poulie de guidage pour enroulement aligné et facilité du câble sur le tambour.

ES

Características

BASE - Base con ojales para la fijación con tirantes o para contra bastidor integrado que permite la limitación de la altura de montaje. Es también disponible, sobre demanda, una base "LP" (Low Profile) para falso chasis integrado para obtener una altura de montaje más contenida.

PATINES DE GUÍA - Patines de guía de los brazos que se pueden sacar, de montaje "forzado" para reducir las holguras verticales y laterales, garantizando una vida útil más larga y patines laterales regulados. Patines especiales con elevado grado de deslizamiento y baja necesidad de engrase.

DEPÓSITO - Depósito de material plástico especialmente resistente a los golpes y a la acción corrosiva de cualquier elemento externo.

ESTABILIZADORES - Estabilizadores con extensión hidráulica y cilindro estabilizador con soporte articulado y piastra de apoyo en monocast. Tuberías al interior del soporte estabilizadores. Control con distribuidor hidráulico independiente, también por vía radio. Disponibilidad opcional de rotación hidráulica de los estabilizadores.

Opcional

FARO PARA TRABAJO - Poderoso y versátil faro de dirección variable, ayuda a trabajar en seguridad, también en condiciones de iluminación escasa del ambiente. Se puede activar mediante el cuadro de pulsadores del radiocomando.

JIB - Articulación hidráulica adicional para aumentar el alcance y desplazar la carga horizontalmente a diferentes alturas (sin perjudicar la prevista configuración de la grúa plegada). Sistema exclusivo Prolink Fassi para aumentar el ángulo de trabajo de las prolongas hidráulicas por encima de la línea horizontal de 20 grados (10 grados L21).

ASIENTO - Puesto ergonómico protegido para permitir al operario un mayor control en caso de operaciones específicas de manipulación y elevación. Posición de trabajo y de los mandos regulables y opción de asiento calefactado.

TUBERÍAS ADICIONALES - Tuberías adicionales para el uso de accesorios hidráulicos, en grúas y en extensiones hidráulicas, protegidas por un sistema Fassi exclusivo constituido por canaletas metálicas combinadas con cadenas de guía de nylon de alta resistencia. Tubos flexibles de alta calidad y resistentes a la acción del ozono.

CABRESTANTE - Dispositivo de elevación por cable equipado con un exclusivo sistema patentado de doble limitador final de carrera mecánico, que evita los riesgos que derivan de las sobrecargas directas e indirectas aplicadas sobre el propio cabrestante. Cable anti giro y polea guiada para rebobinado alineado al tambor.

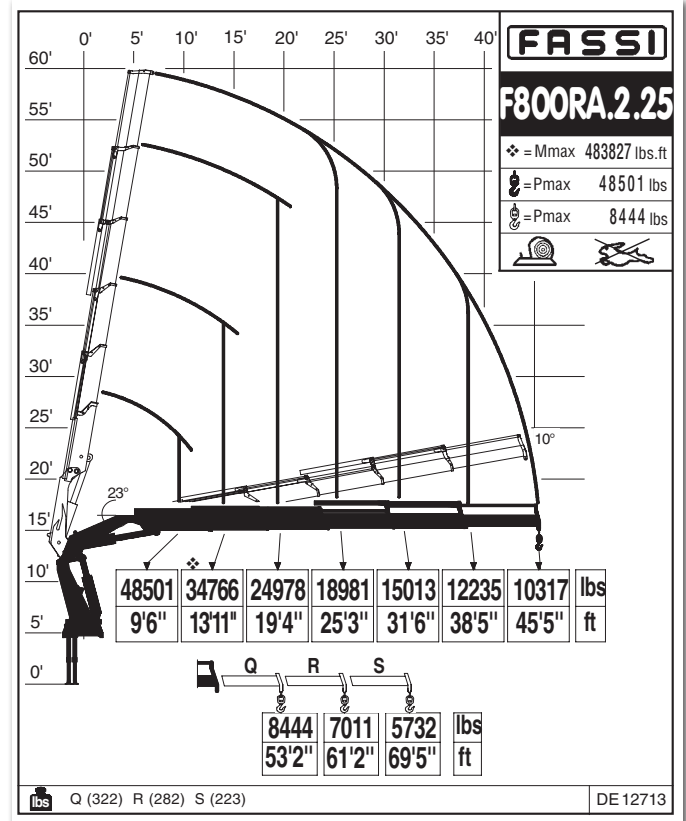
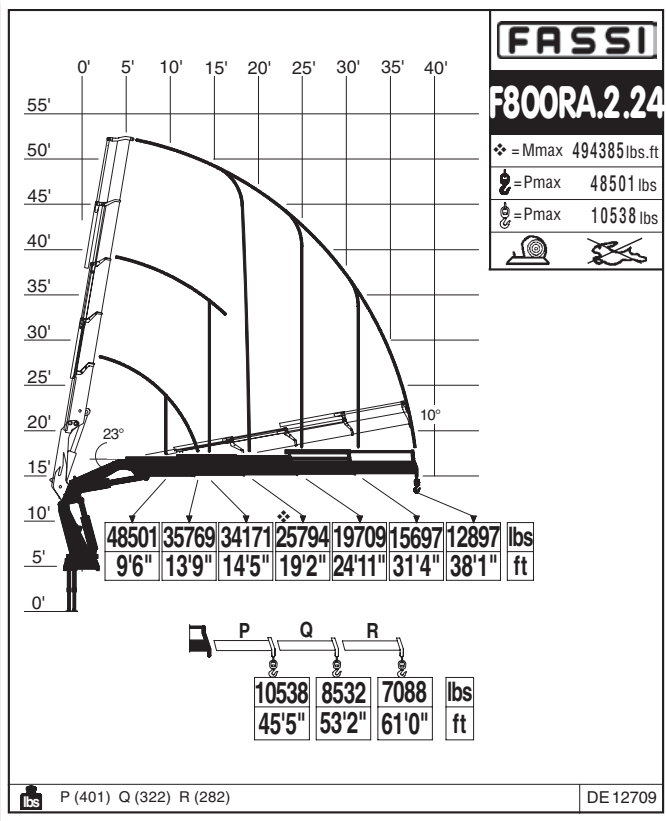
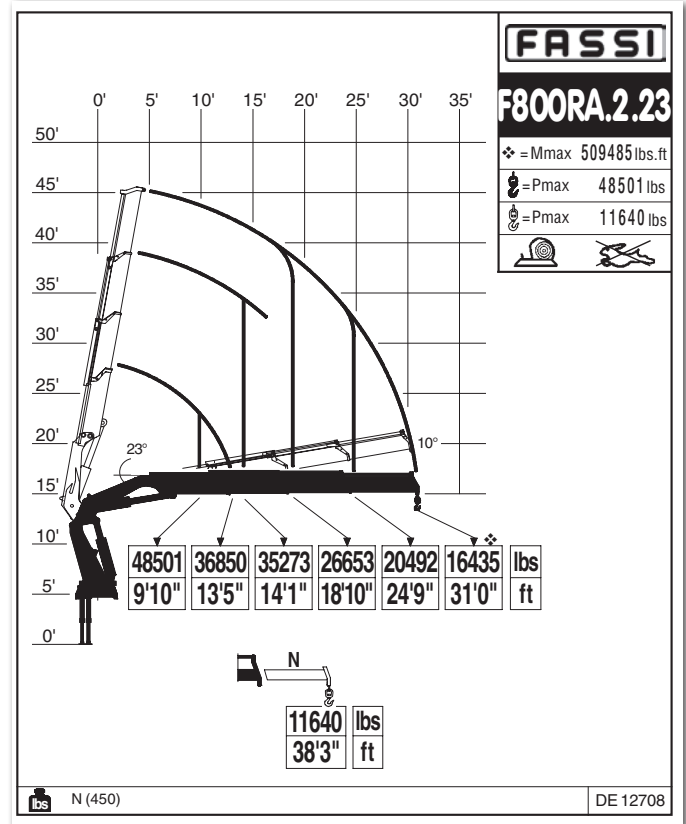
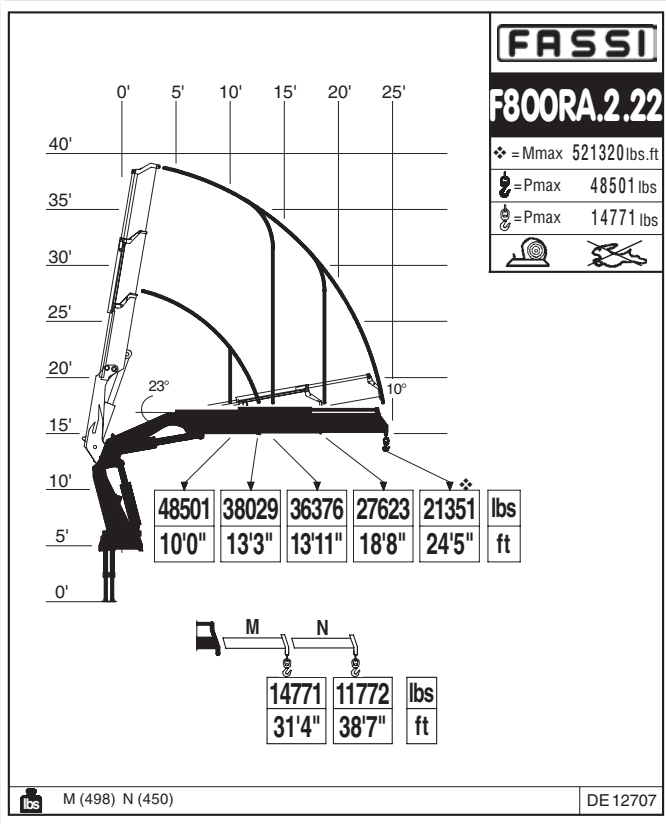

CERTIFIED
DYNAMIC
PERFORMANCE

US Dynamic load diagrams calculated, tested and certified to lift the loads at the declared reaches

FR Diagrammes de charge dynamiques calculés, testés et certifiés pour soulever les charges aux extensions déclarées

ES Diagramas de carga dinámicos, calculados, probados y certificados para a elevación de la cargas a los alcances declarados

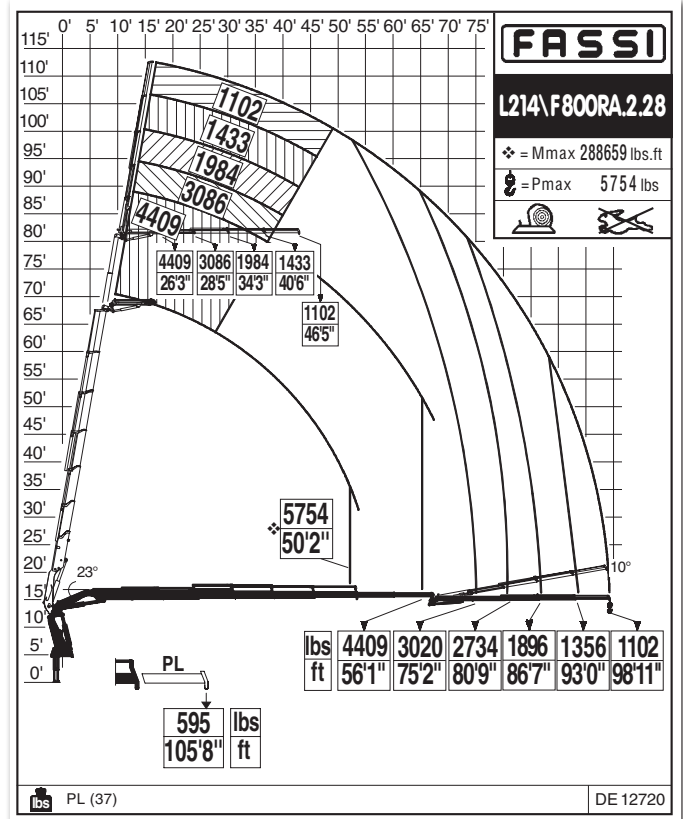
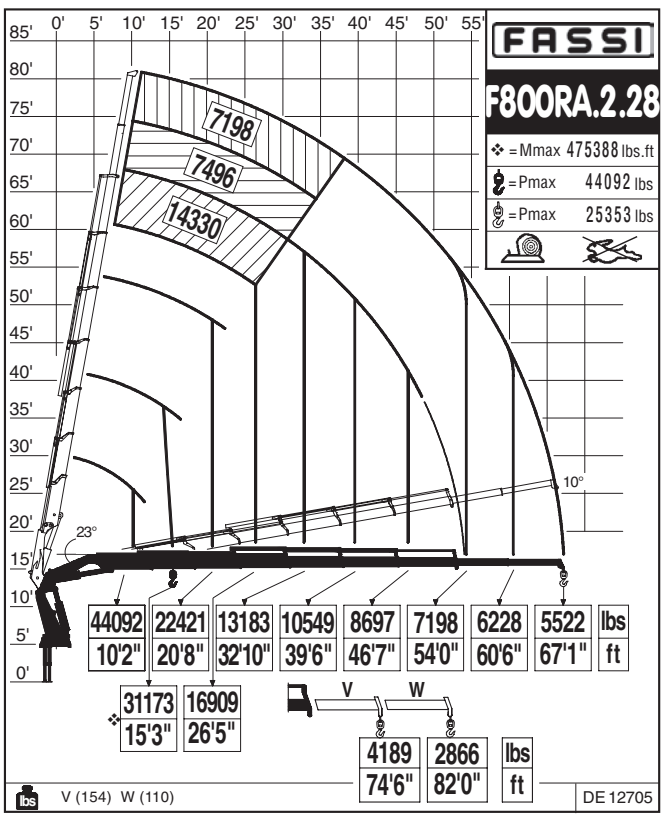
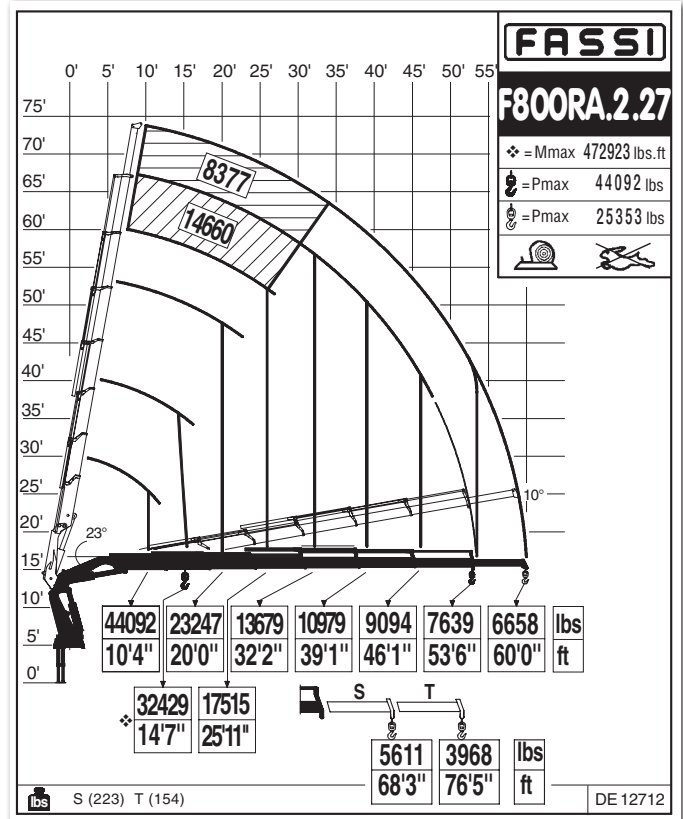
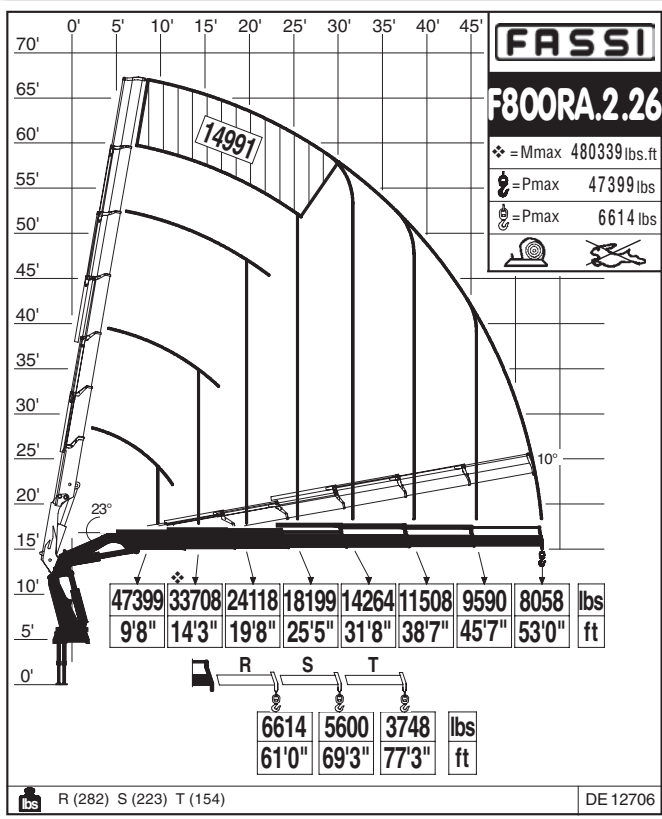













US Dynamic load diagrams calculated, tested and certified to lift the loads at the declared reaches

FR Diagrammes de charge dynamiques calculés, testés et certifiés pour soulever les charges aux extensions déclarées







































ES Diagramas de carga dinámicos, calculados, probados y certificados para a elevación de la cargas a los alcances declarados

F800RA.2

Technical data

lbs/ft												
	lbs.ft	ft	ft	°	lbs.ft	psi	gpm	gal	lbs	ft	ft	ft
F800RA.2.22	521320	25'3"	11'1"	360 CONTINUOUS	66399	4790	21 / 26	70	13448	8'2"	5'0"	8'1"
F800RA.2.23	509485	31'9"	17'6"	360 CONTINUOUS	66399	4790	21 / 26	70	14219	8'2"	5'3"	8'1"
F800RA.2.24	494385	38'10"	24'3"	360 CONTINUOUS	66399	4790	21 / 26	70	14881	8'2"	5'3"	8'1"
F800RA.2.25	483827	46'3"	31'5"	360 CONTINUOUS	66399	4790	21 / 26	70	15542	8'2"	5'3"	8'1"
F800RA.2.26	480339	53'9"	38'8"	360 CONTINUOUS	66399	4790	21 / 26	70	16203	8'4"	5'3"	8'1"
F800RA.2.27	572923	60'10"	45'3"	360 CONTINUOUS	66399	4790	21 / 26	70	16644	8'4"	5'6"	8'1"
F800RA.2.28	475388	67'7"	51'10"	360 CONTINUOUS	66399	4790	21 / 26	70	17085	8'4"	5'6"	8'1"
F800RA.2.25/L515*	483827	80'0"	54'11"	360 CONTINUOUS	66399	4790	21 / 26	70	18805	8'3"	5'10"	9'0"
F800RA.2.25/L516*	483827	85'7"	60'8"	360 CONTINUOUS	66399	4790	21 / 26	70	18628	8'3"	5'10"	9'0"
F800RA.2.26/L413*	480339	79'2"	54'3"	360 CONTINUOUS	66399	4790	21 / 26	70	18298	8'4"	5'10"	9'3"
F800RA.2.26/L414*	480339	85'5"	60'6"	360 CONTINUOUS	66399	4790	21 / 26	70	18518	8'4"	5'10"	9'3"
F800RA.2.26/L515*	480339	86'11"	62'4"	360 CONTINUOUS	66399	4790	21 / 26	70	19422	8'4"	5'10"	8'11"
F800RA.2.26/L516*	480339	92'10"	68'0"	360 CONTINUOUS	66399	4790	21 / 26	70	19731	8'4"	5'10"	8'11"
F800RA.2.27/L425*	572923	93'9"	68'10"	360 CONTINUOUS	66399	4790	21 / 26	70	19069	8'4"	6'1"	9'2"
F800RA.2.27/L426*	572923	99'6"	74'7"	360 CONTINUOUS	66399	4790	21 / 26	70	19290	8'4"	6'1"	9'2"
F800RA.2.28/L213*	475388	93'11"	69'10"	360 CONTINUOUS	66399	4790	21 / 26	70	18562	8'4"	6'1"	9'3"
F800RA.2.28/L214	475388	99'10"	75'9"	360 CONTINUOUS	66399	4790	21 / 26	70	18739	8'4"	6'1"	9'3"

*US / The range of versions available also includes F800RA.2.25 L515, F800RA.2.25 L516, F800RA.2.26 L413/L414, F800RA.2.26 L515/L516, F800RA.2.27 L425/L426, F800RA.2.28 L213 to see the load diagram go to fassitech.com: - FR / La gamme de versions disponibles comprend aussi F800RA.2.25 L515, F800RA.2.25 L516, F800RA.2.26 L413/L414, F800RA.2.26 L515/L516, F800RA.2.27 L425/L426, F800RA.2.28 L213 pour voir le diagramme de charge consulter le site Internet fassitech.com - ES / La gama de versiones disponibles también incluye F800RA.2.25 L515, F800RA.2.25 L516, F800RA.2.26 L413/L414, F800RA.2.26 L515/L516, F800RA.2.27 L425/L426, F800RA.2.28 L213 para ver el diagrama de carga visitar el sitio web fassitech.com

												
	Lifting capacity	Standard reach	Hydraulic extension	Rotation	Rotation torque	Working pressure	Pump capacity	Oil tank capacity	Crane weight	Crane width	Installation width	Crane height
												
	Capacité de levage	Bras standard	Extension hydraulique	Rotation	Couple de rotation	Pression d'utilisation	Débit de la pompe	Capacité du réservoir d'huile	Poids de la grue	Largeur de la grue	Largeur de montage	Hauteur de la grue
												
	Capacidad de elevación	Brazo standard	Extensión hidráulica	Ángulo de rotación	Potencia de rotación	Presión de trabajo	Capacidad de la bomba	Capacidad depósito aceite	Peso de la grúa	Anchura de la grúa	Anchura de montaje	Altura de la grúa

F800RA he-dynamic

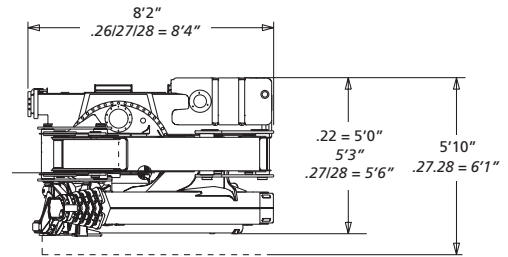
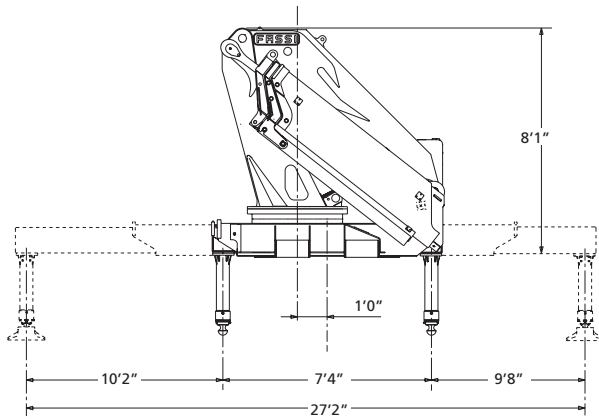

L SERIE

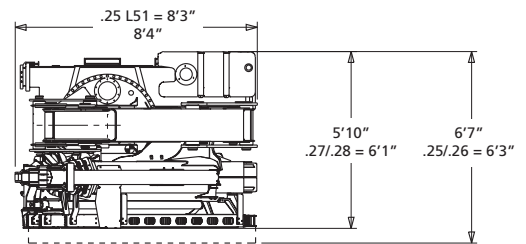
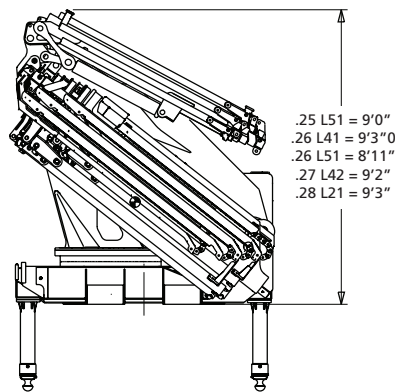

L213	1278 lbs	L214	1432 lbs	L413	1609 lbs	L414	1873 lbs	L425	2425 lbs	L426	2645 lbs	L515	2865 lbs	L516	3086 lbs
NL	63 lbs	PL	46 lbs	NL	127 lbs	PL	70 lbs	QL	121 lbs	RL	79 lbs	QL	121 lbs	RL	79 lbs
PL	46 lbs			PL	70 lbs	QL	48 lbs	RL	79 lbs	SL	55 lbs	RL	79 lbs	SL	55 lbs
				QL	48 lbs			SL	55 lbs	TL	33 lbs	SL	55 lbs	TL	33 lbs

LOW PROFILE

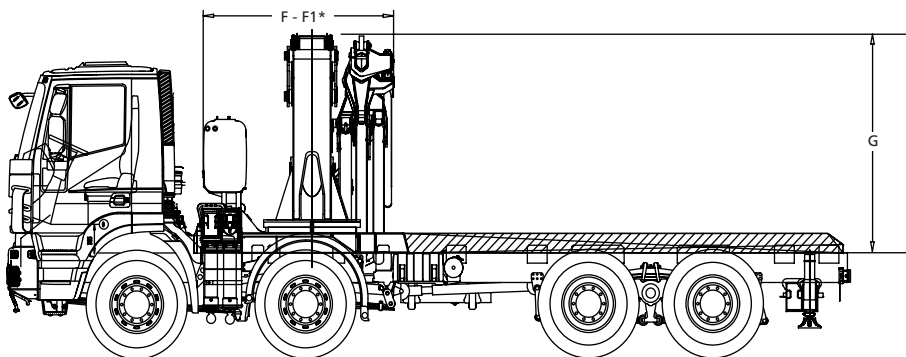

	F	F1*	G
.24	6'10" ft	7'5" ft	7'6" ft
.25	6'10" ft	7'5" ft	7'6" ft
.26	6'10" ft	7'5" ft	7'6" ft
.27	7'1" ft	7'8" ft	7'6" ft
.28	7'1" ft	7'8" ft	7'6" ft
.25/L515	7'4" ft	7'10" ft	8'4" ft
.25/L516	7'4" ft	7'10" ft	8'4" ft
.26/L413	7'4" ft	7'10" ft	8'4" ft
.26/L414	7'4" ft	7'10" ft	8'4" ft
.26/L515	7'4" ft	7'10" ft	8'4" ft
.26/L516	7'4" ft	7'10" ft	8'4" ft
.27/L425	7'4" ft	8'2" ft	8'6" ft
.27/L426	7'4" ft	8'2" ft	8'6" ft
.28/L213	7'4" ft	8'2" ft	8'8" ft
.28/L214	7'4" ft	8'2" ft	8'8" ft

With supplementary hoses
Avec tuyauterie supplementaire
Con tuberias suplementarias



US

ELECTRONIC DOCUMENTATION

All documentation related to the "Techno chips" and the crane is available in electronic format. Require all information you may need directly to your Fassi dealer or download them from the internet site: www.fassi.com.

FR

DOCUMENTATION ELECTRONIQUE

Toutes les informations relatives aux "Techno chips" et aux grues sont disponibles sous format électronique. Elles peuvent être demandées aux concessionnaires Fassi ou téléchargées sur le site www.fassi.com.

ES

DOCUMENTACION ELECTRÓNICA

Toda la información relativa a los "techno chips" y a las grúas está disponible en formato electrónico. Se puede solicitar directamente a los concesionarios Fassi, o bien descargarse on line desde la web www.fassi.com.

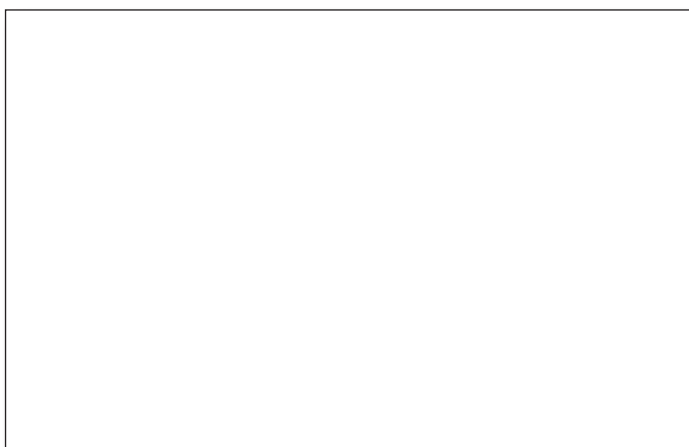

FASSI

www.fassi.com

FASSI GRU S.p.A.
Via Roma, 110
24021 Albino (Bergamo) ITALY
Tel- +39 035 776400
Fax +39 035 755020
<http://www.fassi.com>
E-mail: fassi@fassi.com

COMPANY
WITH QUALITY MANAGEMENT
SYSTEM CERTIFIED BY DNV
=ISO 9001: 2008=