

F235A e-active
F235A e-dynamic

lbs/ft

F235A e-active

F235A e-dynamic



CRANESWITHOUT COMPROMISE

US

F235A e-active

LIFTING CAPACITY:
up to 154063 lbs.ft
MAX OUTREACH:
up to 77'5" with jib
OVERALL DIMENSIONS:
l 2'10" , w 8'0" , h 7'4"
ELECTRONIC/HYDRAULIC EQUIPMENT
control unit FX500
D850 digital distributor bank
RCH/RCS radio remote control unit
flow sharing
CHARACTERISTICS:
active version (.0): without linkage
XP device
rotation 400° with rack and pinion

FR

F235A e-active

CAPACITÉ DE LEVAGE:
jusqu'à 1154063 lbs.ft
BRAS HYDRAULIQUE:
jusqu'à 77'5" avec jib
ENCOMBREMENT GRUE:
l 2'10" , w 8'0" , h 7'4"
ÉQUIPEMENT ÉLECTRONIQUE/HYDRAULIQUE:
unité de contrôle FX500
distributeur hydraulique digitalD850
unité de commande radio RCH/RCS
flow sharing
CARACTÉRISTIQUES:
version active (.0): sans bielle
dispositif XP
rotation 400° avec crémaillère et pignon

ES

F235A e-active

POTENCIA DE ELEVACIÓN:
hasta 1154063 lbs.ft
MÁXIMO ALCANCE HIDRÁULICO:
hasta 77'5" con jib
EMBARAZADO GRÚA:
l 2'10" , w 8'0" , h 7'4"
DOTACIÓN ELECTRÓNICA/HIDRÁULICA:
unidad de control FX500
distribuidor hidráulico digital D850
unidad de mando radio RCH/RCS
flow sharing
CARACTERÍSTICAS:
versión active (.0): sin sistema de bielas
dispositivo XP
rotación 400° con cremallera y piñón

The images are sole purpose of presentation of the product - Les images sont à seule fin de la présentation du produit- Las imágenes son solo propósito de la presentación del producto

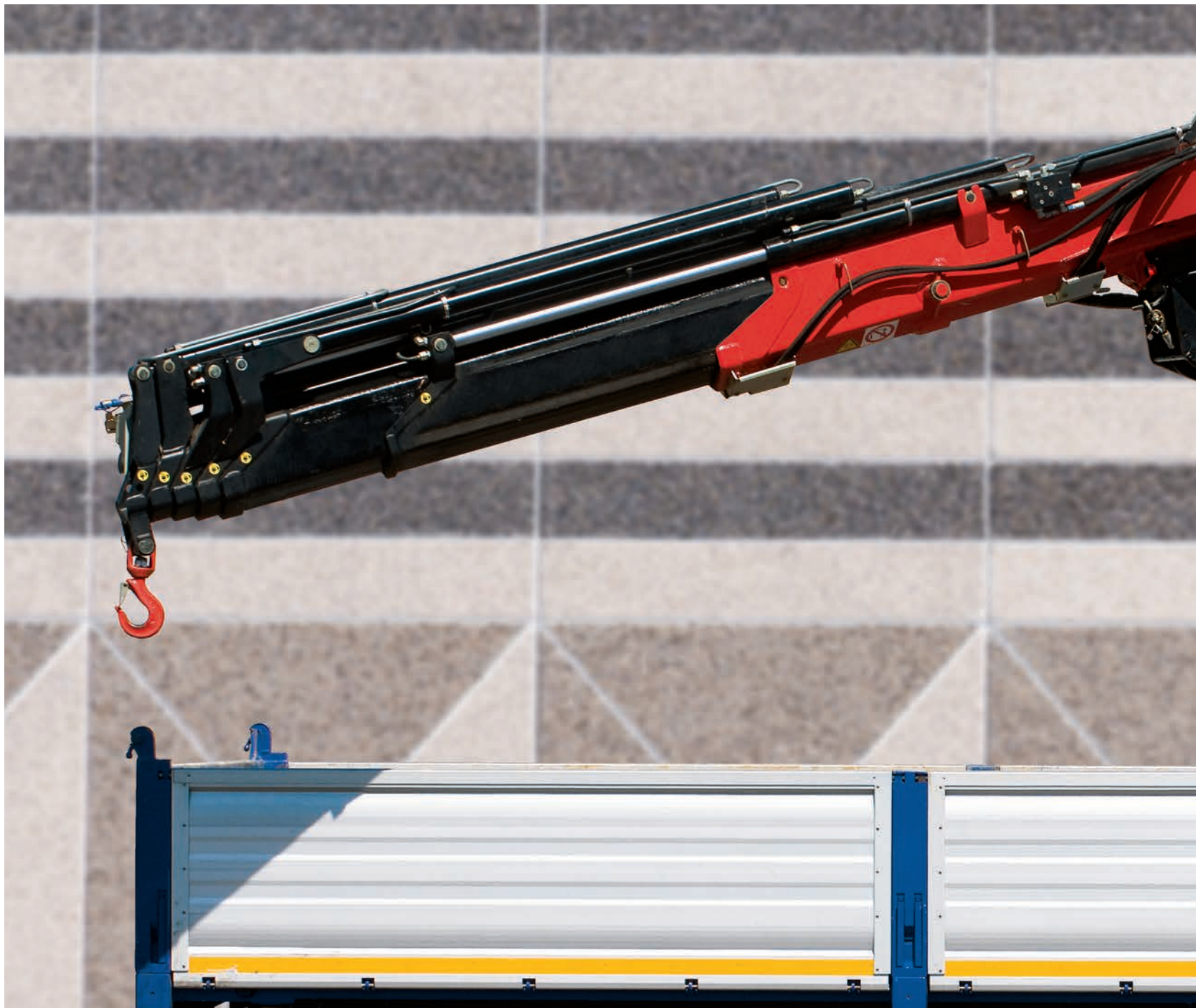

US

F235A e-dynamic

LIFTING CAPACITY:
up to 146830 lbs.ft
MAX OUTREACH:
up to 74'5" with jib
OVERALL DIMENSIONS:
l 3'2" , w 8'3" , h 7'10"
ELECTRONIC/HYDRAULIC EQUIPMENT
FX500 control unit
D850 digital distributor bank
RCH/RCS radio remote control unit
flow sharing
CHARACTERISTICS:
dynamic version (.2): with linkage
XP device
ProLink system with double linkage
rotation 400° with rack and pinion

FR

F235A e-dynamic

CAPACITÉ DE LEVAGE:
jusqu'à 146830 lbs.ft
BRAS HYDRAULIQUE:
jusqu'à 74'5" avec jib
ENCOMBREMENT GRUE:
l 3'2" , w 8'3" , h 7'10"
ÉQUIPEMENT ÉLECTRONIQUE/HYDRAULIQUE:
unité de contrôle FX500
distributeur hydraulique digital D850
unité de commande radio RCH/RCS
flow sharing
CARACTÉRISTIQUES:
version dynamic (.2): avec bielle
dispositif XP
système ProLink avec double bielle
rotation 400° avec crémaillère et pignon

ES

F235A e-dynamic

POTENCIA DE ELEVACIÓN:
hasta 146830 lbs.ft
MÁXIMO ALCANCE HIDRÁULICO:
hasta 74'5" con jib
EMBARAZADO GRÚA:
l 3'2" , w 8'3" , h 7'10"
DOTACIÓN ELECTRÓNICA/HIDRÁULICA:
unidad de control FX500
distribuidor hidráulico digital D850
unidad de mando radio RCH/RCS
flow sharing
CARACTERÍSTICAS:
versión dynamic (.2): con sistema de bielas
dispositivo XP
sistema ProLink y doble mecanismo a biela
rotación 400° con cremallera y piñón

The images are sole purpose of presentation of the product - Les images sont à seule fin de la présentation du produit- Las imágenes son solo propósito de la presentación del producto



F235A e-active - F235A e-dynamic
Gallery







US ROTATION

Rack rotation with self-centring cast iron wear pad: it ensures the correct and constant coupling between the pinion and the rack, avoiding the wear and tear of the teeth.

FR ROTATION

Rotation à crémaillère avec patins en fonte autocentrants : ils garantissent un couplage correct et constant entre le pignon et la crémaillère permettant ainsi d'éviter l'usure des dents.

ES ROTACIÓN

Rotación de cremallera con patines de fundición autocentrados: garantizan un acoplamiento constante y correcto entre el piñón y la cremallera, evitando el desgaste de los dientes.

US

Features

BASE - Base and lower part of the column in cast steel for perfect stress distribution and greater resistance. The absence of welding ensures that the crane offers excellent characteristics of durability to fatigue.

BOOMS GUIDE - Extension booms guide shoes, with "forced" assembly to reduce vertical and horizontal clearance, ensuring greater durability. Special guide shoes material with high sliding degree and low greasing request.

TANK - Plastic tank, particularly resistant to shocks and the corrosive action of any external element.

LUBRICATION SYSTEM - Centralised lubrication system of the base to guarantee easier access for maintenance and control operations.

OUTRIGGER - Hydraulically extendable outriggers also in "Extra wide" and "Super Extra wide" execution, with hoses fitted inside the outrigger supports (standard only on dynamic crane version). Independent hydraulic distributor for the control of the outriggers; it can be also activated by radio control (option). Available as option manual or hydraulic tiltable outriggers.

VERSION C - Crane version with a shorter secondary arm, to allow a greater height of under-hook lifting. Offers the possibility to lift especially bulky and heavy loads vertically, near the column of the crane. Automatic hooking system for the positioning of the extension booms in transport position when crane is folded behind cab.

Optional

WORKLIGHT - Powerful and versatile light that can be directed as required: helps you to work safely, even in conditions of poor natural light. Can be activated by means of the radio remote control pushbuttons or by the user panel.

JIB - Additional hydraulic articulation that allows you to increase the reach of the crane and, once the required height has been reached, to move the load horizontally in relation to the ground (without jeopardising the correct resting configuration of the crane).

SEAT - Ergonomic, protected position to allow the operator greater control when carrying out specific movement and lifting operations. There are many possibilities of adjustments to find out the most comfortable working and control position and heated top seat as option.

SUPPLEMENTARY FUNCTIONS - Supplementary functions for the use of hydraulic accessories on the crane and the jib, protected by an exclusive Fassi system consisting of metal trays paired with highly resistant nylon guide-chains. High quality hoses resistant to the ozone action.

WINCH - Cable-operated lifting device equipped with an exclusive, patented mechanical, torque and end stop limiter system which avoids the risks resulting from direct and indirect overload applied to the winch itself. Anti-revolving cable and cable guide pulley to make easy the aligned winding of the cable on the winch drum.

FR

Caractéristiques

EMBASE - Embase et partie inférieure de la colonne en fusion d'acier pour une répartition optimum des sollicitations et pour une résistance supérieure. L'absence de soudures assure à la grue une longévité exceptionnelle.

PATINS DE GUIDAGE - Patins de guidage sur les bras d'extension, à montage "forcé" afin de réduire les jeux verticaux et latéraux prolongeant ainsi la durée de vie de l'ensemble. Patins en matériel spécial avec un degré de glissement élevé et demande réduite d'engraissage.

RÉSERVOIR - Réservoir en matière plastique très résistant aux chocs et à l'action corrosive de tout élément extérieur.

SYSTÈME DE LUBRIFICATION - Système de lubrification de l'embase centralisé pour garantir l'accès aux opérations d'entretien et de contrôle.

STABILISATEURS - Stabilisateurs à extension hydraulique disponible aussi en version "Extra large" et « Super Extra large », avec tuyauteries à l'intérieur du support des stabilisateurs (standard seulement sur version dynamic). Distributeur hydraulique dédié pour commande manuelle ou radio (en option) des stabilisateurs. Disponibilité comme option des stabilisateurs pivotants manuellement ou hydrauliquement.

VERSION C - Version de la grue avec un bras secondaire plus court, de manière à obtenir une hauteur sous crochet plus importante. Elle donne la possibilité de soulever verticalement, au plus près de la colonne de la grue, des charges très encombrantes et lourdes. Système d'accrochage automatique pour le positionnement des bras d'extension en position de transport avec grue repliée derrière cabine.

En option

PHARE DE TRAVAIL - Phare directionnel variable, puissant et adaptable, qui permet de travailler en toute sécurité même avec une mauvaise visibilité. Peut être activé également avec les boutons de la radiocommande ou du panneau utilisateur.

JIB - Articulation hydraulique supplémentaire permettant d'augmenter l'extension de la grue et, une fois la hauteur désirée atteinte, de déplacer la charge horizontalement par rapport au sol (sans intervenir sur la configuration initiale de la grue au repos).

SIÈGE - Poste ergonomique et protégé qui permet à l'opérateur un contrôle optimal lors d'opérations de déplacement et de levage spécifiques. Position de travail et des commandes réglable et option siège réchauffé.

TUYAUTERIES SUPPLÉMENTAIRES - Tuyauteries supplémentaires pour l'utilisation d'accessoires hydrauliques, sur grues et sur rallonges hydrauliques, protégées par un système exclusif Fassi se composant de supports en métal couplés à des chaînes de guidage en nylon à haute résistance. Tuyauteries flexibles de grande qualité résistantes à l'ozone.

TREUIL - Dispositif de levage par câble équipé du système exclusif breveté de limiteur de couple et de fin de course mécanique, évitant les risques de toute surcharge directe ou indirecte infligée au treuil. Câble anti-giratoire et poulie de guidage pour enroulement aligné et facilité du câble sur le tambour.

ES

Características

BASE - Base y parte inferior de la columna de fusión de acero para una distribución ideal de los esfuerzos y para una resistencia superior. La ausencia de soldaduras confiere a la grúa excepcionales características de resistencia a la fatiga.

PATINES DE GUÍA - Patines de guía de los brazos extensibles, con montaje "forzado" para reducir las holguras verticales y laterales, garantizando una vida útil más larga. Patines especiales con elevado grado de deslizamiento y baja necesidad de engrase.

DEPÓSITO - Depósito de material plástico especialmente resistente a los golpes y a la acción corrosiva de cualquier elemento externo.

SISTEMA DE LUBRICACIÓN - Sistema de lubricación centralizada de la base para garantizar un acceso más fácil en las operaciones de mantenimiento y control.

ESTABILIZADORES - Estabilizadores con extensión hidráulica también en versión "Extra extensible" y "Super Extra extensible" y tuberías al interior del soporte estabilizadores (estandar solo sobre Dynamic versión). Control con distribuidor hidráulico independiente, también por vía radio (option). Disponibilidad opcional de estabilizadores rotantes manual o hidráulico.

VERSIÓN C - Versión de grúa con un brazo secundario más corto, con el fin de permitir una mayor altura de elevación debajo del gancho. Ofrece la posibilidad de levantar en vertical, cerca de la columna de la grúa, cargas especialmente grandes y pesadas. Sistema de enganche automático para el posicionamiento de los brazos extensibles en posición de transporte con la grúa plegada detrás de la cabina.

Opcional

FARO PARA TRABAJO - Poderoso y versátil faro de dirección variable, ayuda a trabajar en seguridad, también en condiciones de iluminación escasa del ambiente. Se puede activar también mediante el cuadro de pulsadores del radiocomando o del panel de usuario.

JIB - Articulación hidráulica adicional que permite aumentar el alcance de la grúa y, después de haberse alcanzado la altura deseada, desplazar la carga horizontalmente con respecto al terreno (sin perjudicar la prevista configuración en reposo de la grúa).

ASIENTO - Puesto ergonómico protegido para permitir al operario un mayor control en caso de operaciones específicas de manipulación y elevación. Posición de trabajo y de los mandos regulables y opción de asiento calefactado.

TUBERÍAS ADICIONALES - Tuberías adicionales para el uso de accesorios hidráulicos, en grúas y en extensiones hidráulicas, protegidas por un sistema Fassi exclusivo constituido por canaletas metálicas combinadas con cadenas de guía de nylon de alta resistencia. Tubos flexibles de alta calidad y resistentes a la acción del ozono.

CABRESTANTE - Dispositivo de elevación por cable equipado con un exclusivo sistema patentado de doble limitador final de carrera mecánico, que evita los riesgos que derivan de las sobrecargas directas e indirectas aplicadas sobre el propio cabrestante. Cable anti giro y polea guiada para rebobinado alineado al tambor.



F235A e-dynamic



US LINKAGE

Linkage on crane articulations, maintaining a constant lifting moment and better crane performances in terms of both dynamic lifting and static capacity.

FR BIELLETTE

Système de biellette sur articulations de la grue, permettent de maintenir un moment de levage constant et performances supérieures en termes tant de levage dynamique que de capacités statiques.

ES MECANISMO A BIELA

Mecanismo a biela de las articulaciones de la grúa, que permite obtener un momento de levantamiento constante y mayor capacidad en términos sea de levantamiento dinámico que de capacidad estática.

US

Features

BASE - Base and lower part of the column in cast steel for perfect stress distribution and greater resistance. The absence of welding ensures that the crane offers excellent characteristics of durability to fatigue.

BOOMS GUIDE - Extension booms guide shoes, with "forced" assembly to reduce vertical and horizontal clearance, ensuring greater durability. Special guide shoes material with high sliding degree and low greasing request.

TANK - Plastic tank, particularly resistant to shocks and the corrosive action of any external element.

LUBRICATION SYSTEM - Centralised lubrication system of the base to guarantee easier access for maintenance and control operations.

OUTRIGGER - Hydraulically extendable outriggers also in "Extra wide" and "Super Extra wide" execution, with hoses fitted inside the outrigger supports (standard only on dynamic crane version). Independent hydraulic distributor for the control of the outriggers; it can be also activated by radio control (option). Available as option manual or hydraulic tilttable outriggers.

VERSION C - Crane version with a shorter secondary arm, to allow a greater height of under-hook lifting. Offers the possibility to lift especially bulky and heavy loads vertically, near the column of the crane. Automatic hooking system for the positioning of the extension booms in transport position when crane is folded behind cab.

Optional

WORKLIGHT - Powerful and versatile light that can be directed as required: helps you to work safely, even in conditions of poor natural light. Can be activated by means of the radio remote control pushbuttons or by the user panel.

JIB - Additional hydraulic articulation that allows you to increase the reach of the crane and, once the required height has been reached, to move the load horizontally in relation to the ground (without jeopardising the correct resting configuration of the crane). Exclusive Fassi ProLink system allowing to increase the working angle of the jib by 10 degrees above the horizontal line.

SEAT - Ergonomic, protected position to allow the operator greater control when carrying out specific movement and lifting operations. There are many possibilities of adjustments to find out the most comfortable working and control position and heated top seat as option.

SUPPLEMENTARY FUNCTIONS - Supplementary functions for the use of hydraulic accessories on the crane and the jib, protected by an exclusive Fassi system consisting of metal trays paired with highly resistant nylon guide-chains. High quality hoses resistant to the ozone action.

WINCH - Cable-operated lifting device equipped with an exclusive, patented mechanical, torque and end stop limiter system which avoids the risks resulting from direct and indirect overload applied to the winch itself. Anti-revolving cable and cable guide pulley to make easy the aligned winding of the cable on the winch drum.

FR

Caractéristiques

EMBASE - Embase et partie inférieure de la colonne en fusion d'acier pour une répartition optimum des sollicitations et pour une résistance supérieure. L'absence de soudures assure à la grue une longévité exceptionnelle.

PATINS DE GUIDAGE - Patins de guidage sur les bras d'extension, à montage "forcé" afin de réduire les jeux verticaux et latéraux prolongeant ainsi la durée de vie de l'ensemble. Patins en matériel spécial avec un degré de glissement élevé et demande réduite d'engraissage.

RÉSERVOIR - Réservoir en matière plastique très résistant aux chocs et à l'action corrosive de tout élément extérieur.

SYSTÈME DE LUBRIFICATION - Système de lubrification de l'embase centralisé pour garantir l'accès aux opérations d'entretien et de contrôle.

STABILISATEURS - Stabilisateurs à extension hydraulique disponible aussi en version "Extra large" et « Super Extra large », avec tuyauteries à l'intérieur du support des stabilisateurs (standard seulement sur version dynamic). Distributeur hydraulique dédié pour commande manuelle ou radio (en option) des stabilisateurs. Disponibilité comme option des stabilisateurs pivotants manuellement ou hydrauliquement.

VERSION C - Version de la grue avec un bras secondaire plus court, de manière à obtenir une hauteur sous crochet plus importante. Elle donne la possibilité de soulever verticalement, au plus près de la colonne de la grue, des charges très encombrantes et lourdes. Système d'accrochage automatique pour le positionnement des bras d'extension en position de transport avec grue repliée derrière cabine.

En option

PHARE DE TRAVAIL - Phare directionnel variable, puissant et adaptable, qui permet de travailler en toute sécurité même avec une mauvaise visibilité. Peut être activé également avec les boutons de la radiocommande ou du panneau utilisateur.

JIB - Articulation hydraulique supplémentaire permettant d'augmenter l'extension de la grue et, une fois la hauteur désirée atteinte, de déplacer la charge horizontalement par rapport au sol (sans intervenir sur la configuration initiale de la grue au repos). Système ProLink Fassi exclusif augmentant l'angle de travail des rallonges hydrauliques de 10 degrés au-dessus de la ligne horizontale.

SIÈGE - Poste ergonomique et protégé qui permet à l'opérateur un contrôle optimal lors d'opérations de déplacement et de levage spécifiques. Position de travail et des commandes réglable et option siège réchauffé.

TUYAUTERIES SUPPLÉMENTAIRES - Tuyauteries supplémentaires pour l'utilisation d'accessoires hydrauliques, sur grues et sur rallonges hydrauliques, protégées par un système exclusif Fassi se composant de supports en métal couplés à des chaînes de guidage en nylon à haute résistance. Tuyauteries flexibles de grande qualité résistantes à l'ozone.

TREUIL - Dispositif de levage par câble équipé du système exclusif breveté de limiteur de couple et de fin de course mécanique, évitant les risques de toute surcharge directe ou indirecte infligée au treuil. Câble anti-giratoire et poulie de guidage pour enroulement aligné et facilité du câble sur le tambour.

ES

Características

BASE - Base y parte inferior de la columna de fusión de acero para una distribución ideal de los esfuerzos y para una resistencia superior. La ausencia de soldaduras confiere a la grúa excepcionales características de resistencia a la fatiga.

PATINES DE GUÍA - Patines de guía de los brazos extensibles, con montaje "forzado" para reducir las holguras verticales y laterales, garantizando una vida útil más larga. Patines especiales con elevado grado de deslizamiento y baja necesidad de engrase.

DEPÓSITO - Depósito de material plástico especialmente resistente a los golpes y a la acción corrosiva de cualquier elemento externo.

SISTEMA DE LUBRICACIÓN - Sistema de lubricación centralizada de la base para garantizar un acceso más fácil en las operaciones de mantenimiento y control.

ESTABILIZADORES - Estabilizadores con extensión hidráulica también en versión "Extra extensible" y "Super Extra extensible" y tuberías al interior del soporte estabilizadores (estandar solo sobre Dynamic versión). Control con distribuidor hidráulico independiente, también por vía radio (option). Disponibilidad opcional de estabilizadores rotantes manual o hidráulico.

VERSIÓN C - Versión de grúa con un brazo secundario más corto, con el fin de permitir una mayor altura de elevación debajo del gancho. Ofrece la posibilidad de levantar en vertical, cerca de la columna de la grúa, cargas especialmente grandes y pesadas. Sistema de enganche automático para el posicionamiento de los brazos extensibles en posición de transporte con la grúa plegada detrás de la cabina.

Opcional

FARO PARA TRABAJO - Poderoso y versátil faro de dirección variable, ayuda a trabajar en seguridad, también en condiciones de iluminación escasa del ambiente. Se puede activar también mediante el cuadro de pulsadores del radiocomando o del panel de usuario.

JIB - Articulación hidráulica adicional que permite aumentar el alcance de la grúa y, después de haberse alcanzado la altura deseada, desplazar la carga horizontalmente con respecto al terreno (sin perjudicar la prevista configuración en reposo de la grúa). Sistema exclusivo ProLink Fassi para aumentar el ángulo de trabajo de las prolongas hidráulicas por encima de la línea horizontal de 10 grados.

ASIENTO - Puesto ergonómico protegido para permitir al operario un mayor control en caso de operaciones específicas de manipulación y elevación. Posición de trabajo y de los mandos regulables y opción de asiento calefactado.

TUBERÍAS ADICIONALES - Tuberías adicionales para el uso de accesorios hidráulicos, en grúas y en extensiones hidráulicas, protegidas por un sistema Fassi exclusivo constituido por canaletas metálicas combinadas con cadenas de guía de nylon de alta resistencia. Tubos flexibles de alta calidad y resistentes a la acción del ozono.

CABRESTANTE - Dispositivo de elevación por cable equipado con un exclusivo sistema patentado de doble limitador final de carrera mecánico, que evita los riesgos que derivan de las sobrecargas directas e indirectas aplicadas sobre el propio cabrestante. Cable anti giro y polea guiada para rebobinado alineado al tambor.





Strada Gerbido
dal n° 136 al n° 150

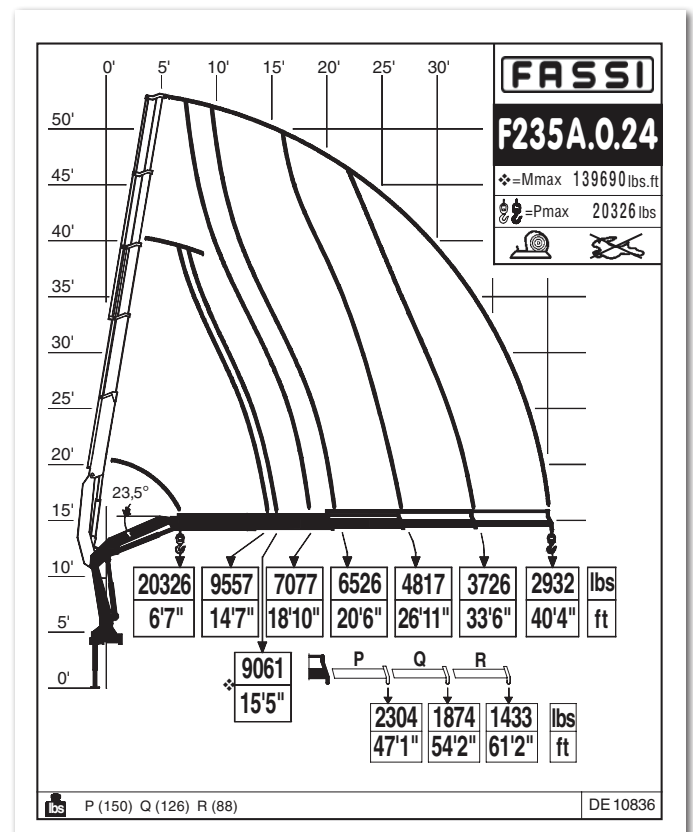
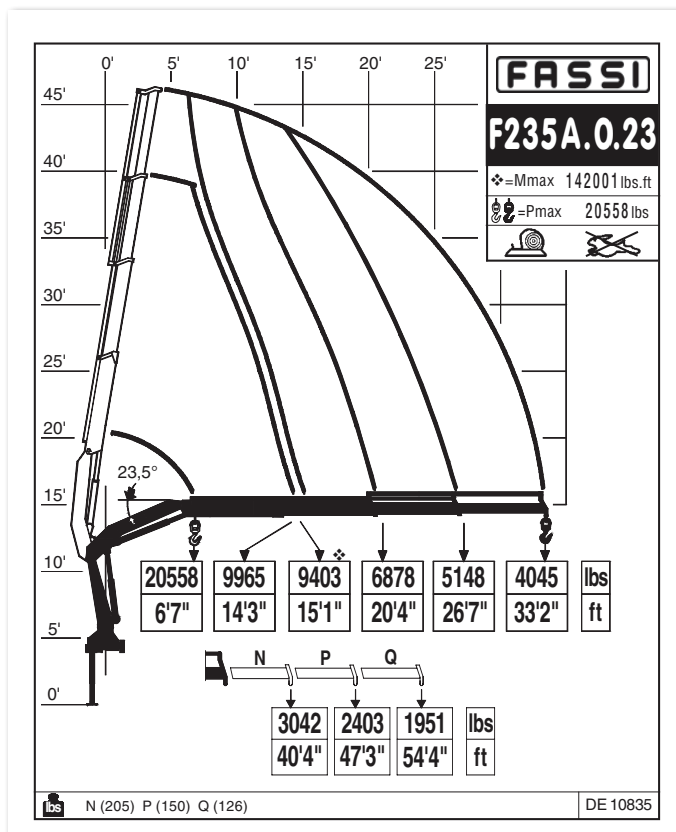
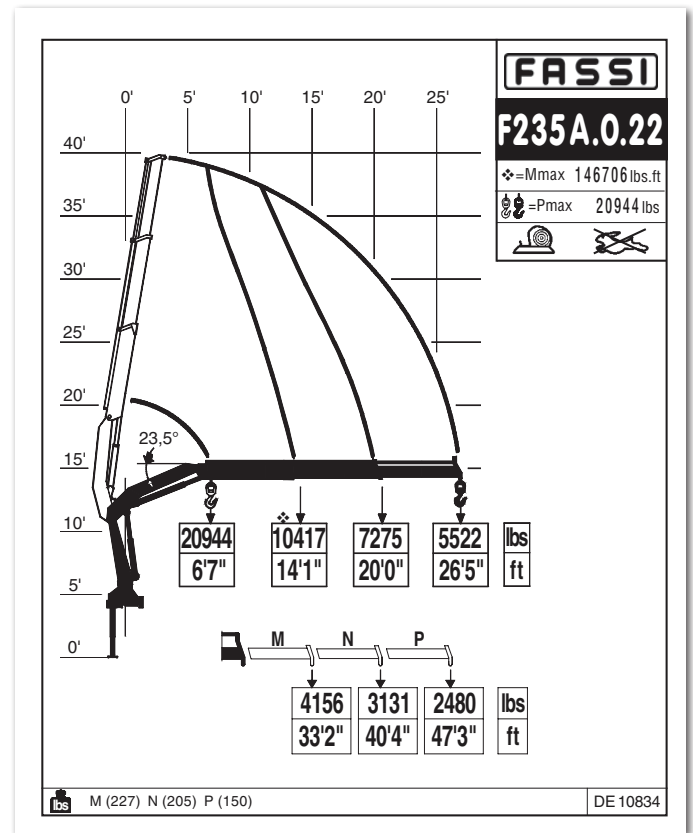
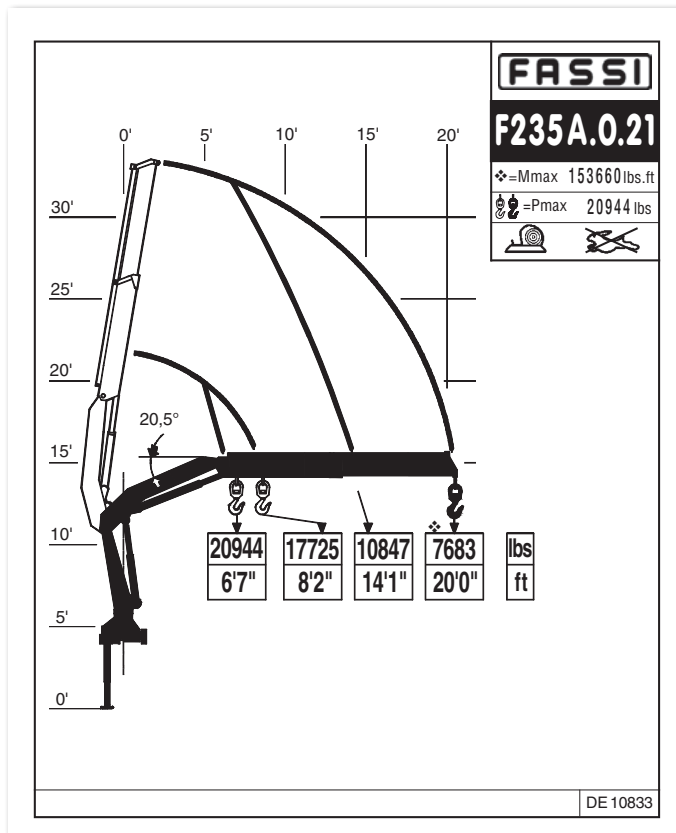

CERTIFIED
DYNAMIC
PERFORMANCE

US Dynamic load diagrams calculated, tested and certified to lift the loads at the declared reaches
 FR Diagrammes de charge dynamiques calculés, testés et certifiés pour soulever les charges aux extensions déclarées
 ES Diagramas de carga dinámicos, calculados, probados y certificados para a elevación de la cargas a los alcances declarados

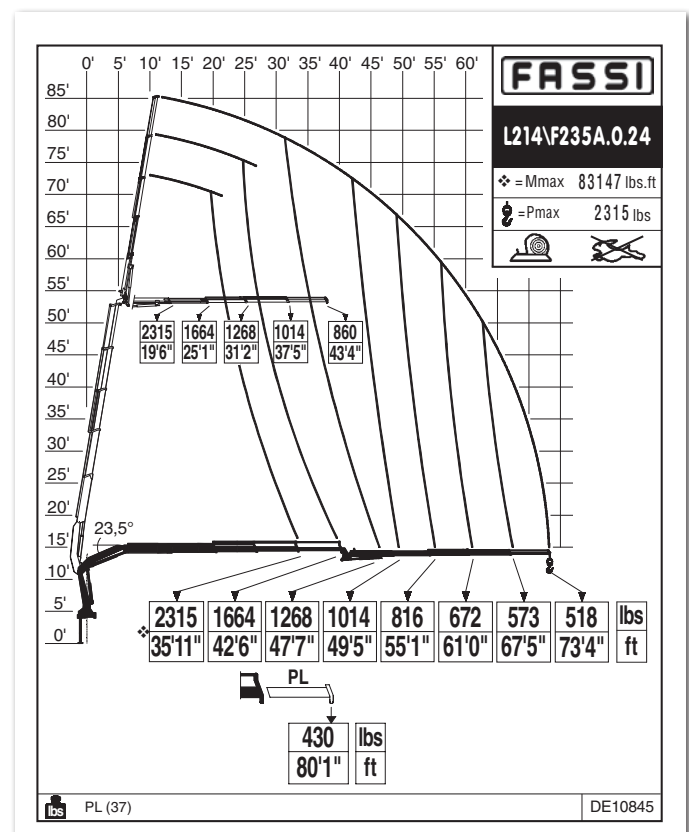
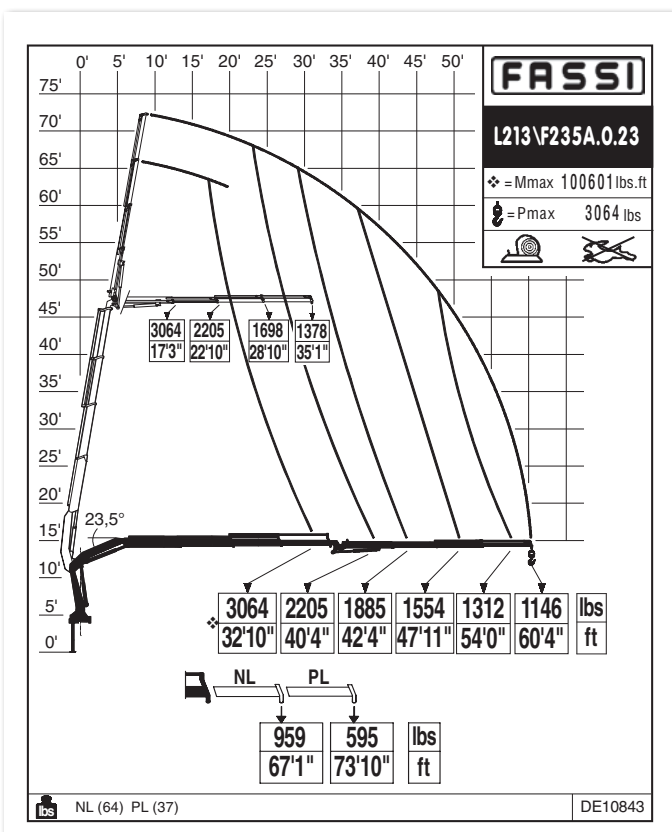
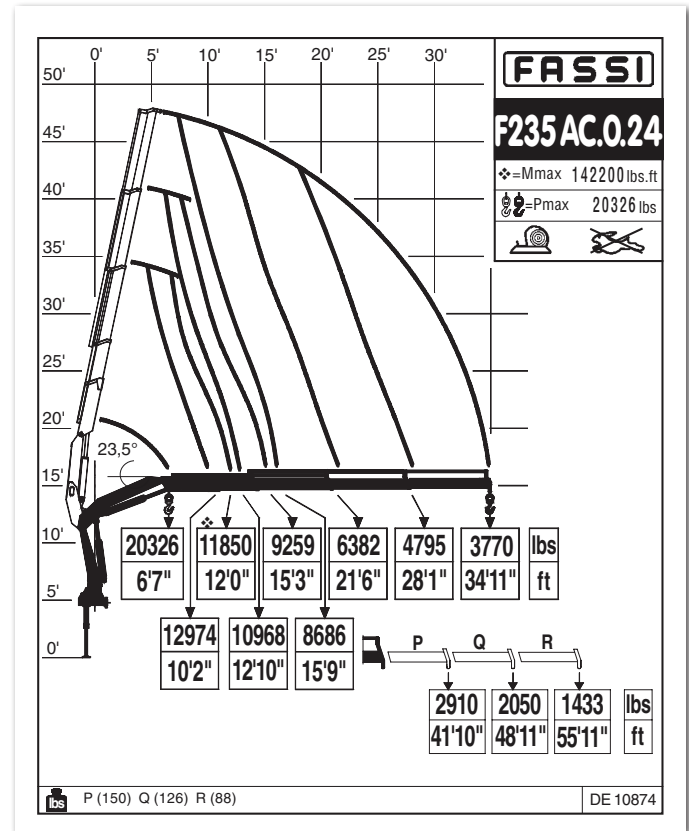
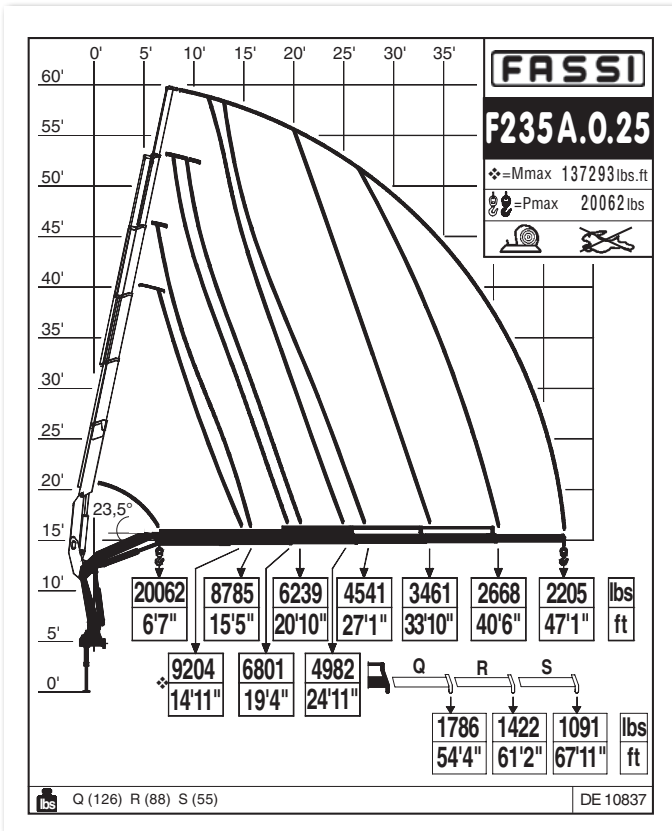

CERTIFIED
DYNAMIC
PERFORMANCE

US Dynamic load diagrams calculated, tested and certified to lift the loads at the declared reaches
 FR Diagrammes de charge dynamiques calculés, testés et certifiés pour soulever les charges aux extensions déclarées
 ES Diagramas de carga dinámicos, calculados, probados y certificados para a elevación de la cargas a los alcances declarados

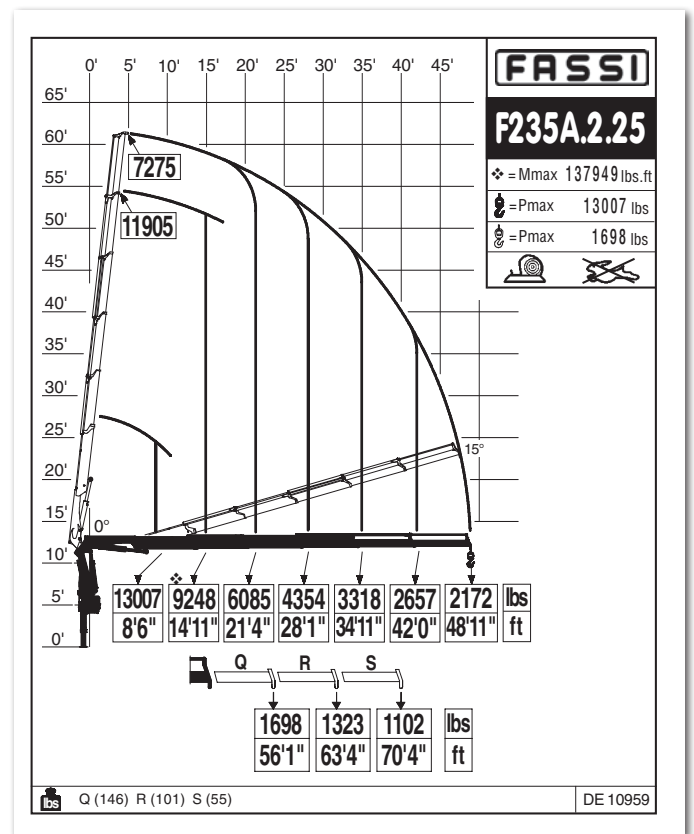
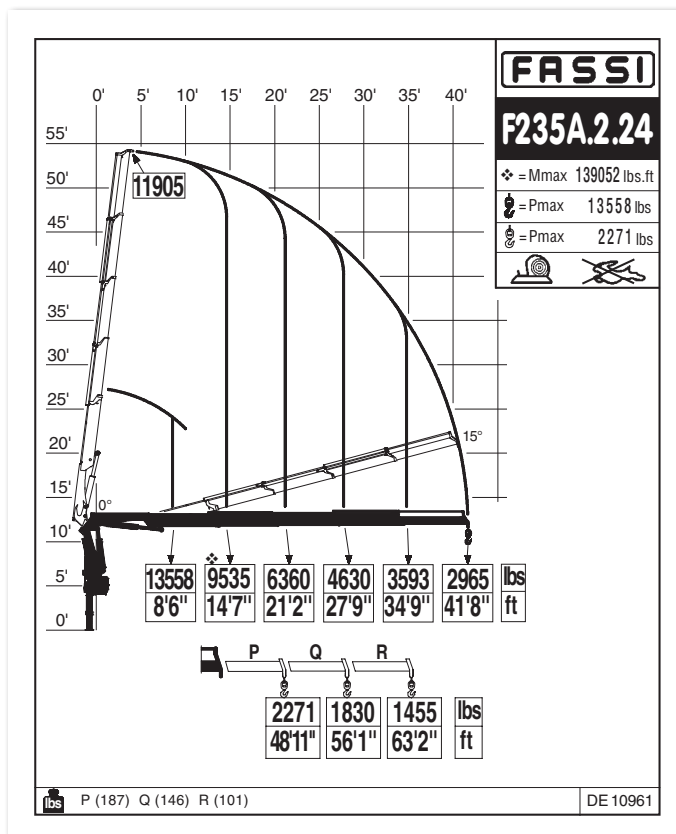
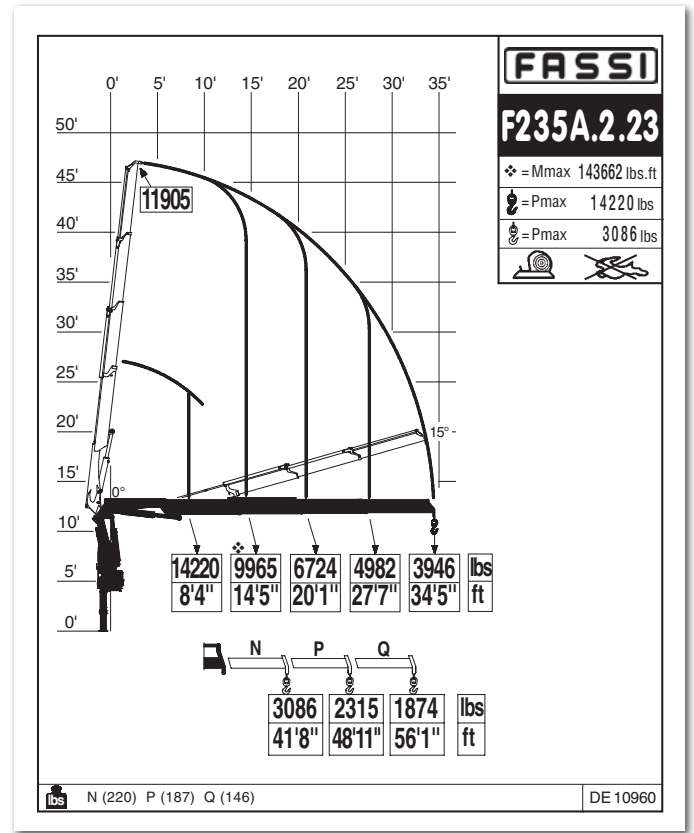
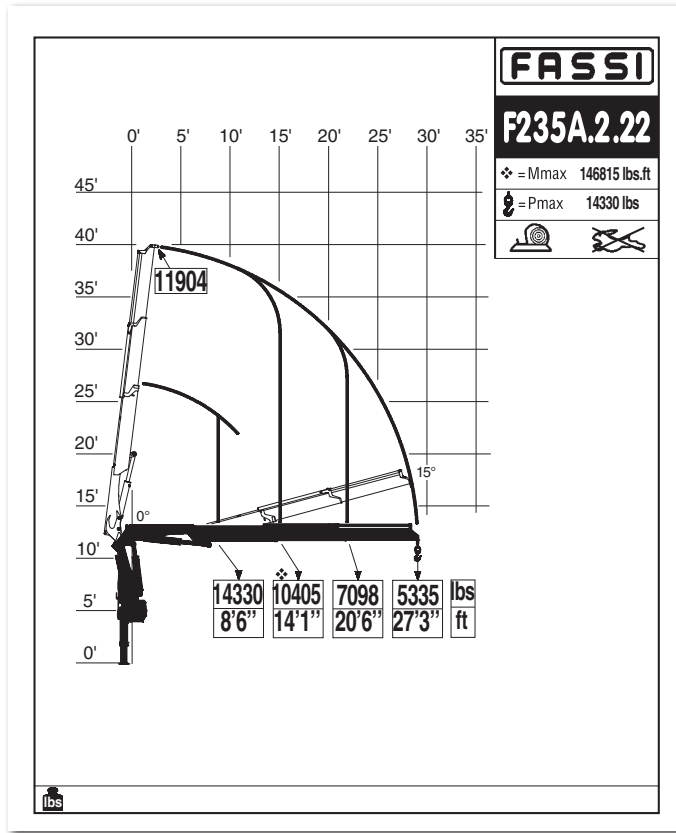

CERTIFIED
DYNAMIC
PERFORMANCE

US Dynamic load diagrams calculated, tested and certified to lift the loads at the declared reaches
 FR Diagrammes de charge dynamiques calculés, testés et certifiés pour soulever les charges aux extensions déclarées
 ES Diagramas de carga dinámicos, calculados, probados y certificados para a elevación de la cargas a los alcances declarados

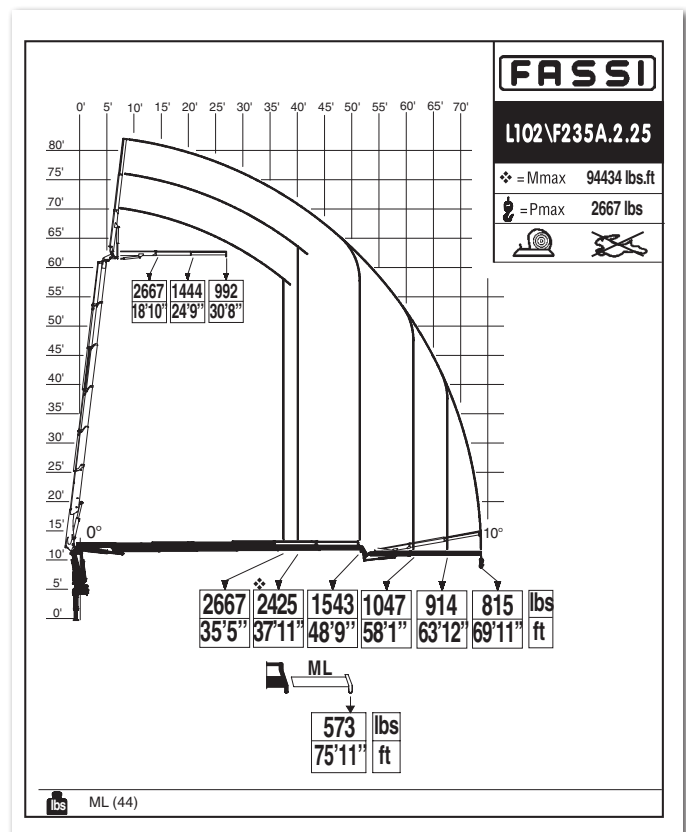
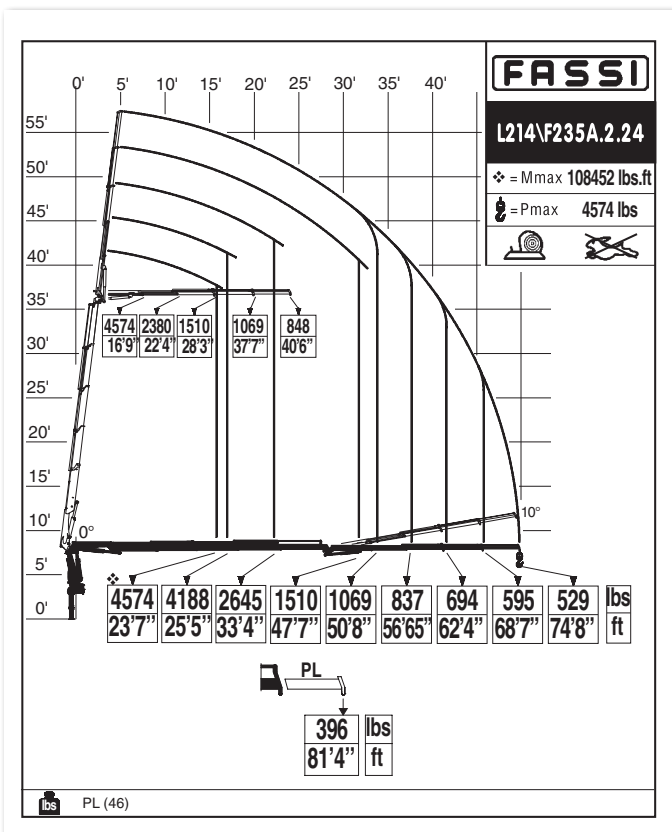
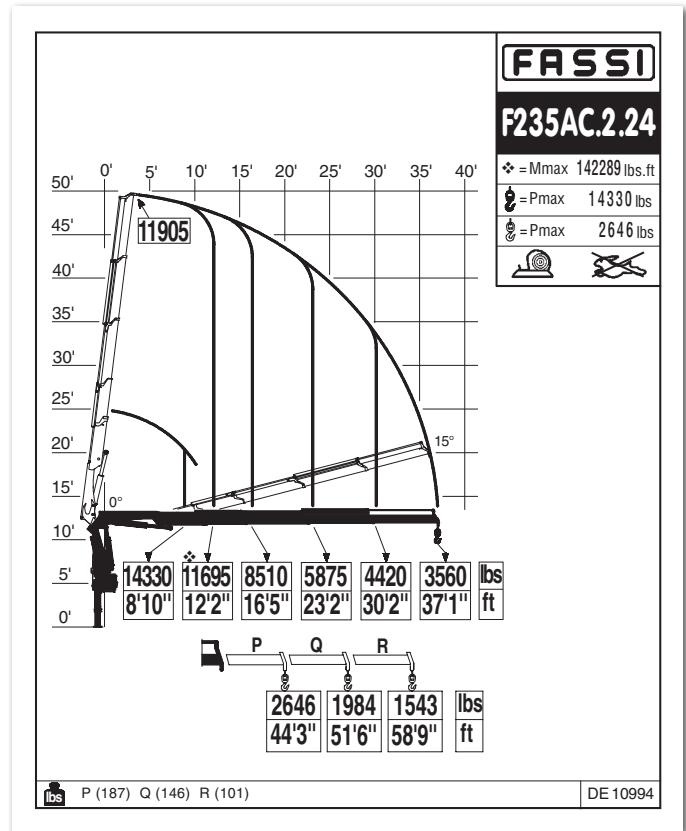
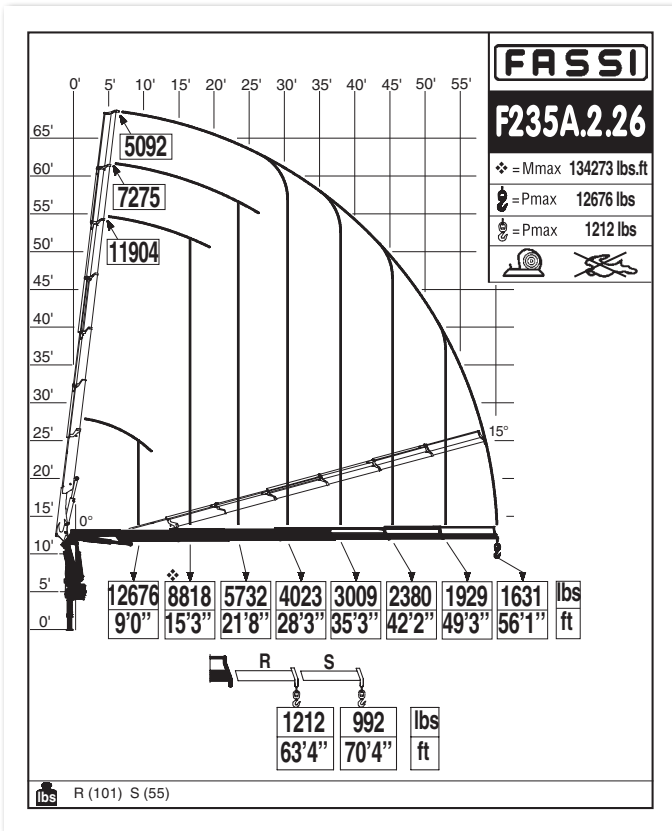













CERTIFIED
DYNAMIC
PERFORMANCE















US Dynamic load diagrams calculated, tested and certified to lift the loads at the declared reaches
 FR Diagrammes de charge dynamiques calculés, testés et certifiés pour soulever les charges aux extensions déclarées
 ES Diagramas de carga dinámicos, calculados, probados y certificados para a elevación de la cargas a los alcances declarados

F235A e-active

Technical data

lbs/ft												
	lbs.ft	ft	ft	°	lbs.ft	psi	gpm	gal	lbs	ft	ft	ft
F235A.0.21	153340	20'8"	5'10"	400	26559	4640	12 - 17	32	4420	8'0"	2'10"	7'4"
F235A.0.22	146757	27'2"	12'3"	400	26559	4640	12 - 17	32	4806	8'0"	2'10"	7'4"
F235A.0.23	142273	34'1"	18'10"	400	26559	4640	12 - 17	32	5191	8'0"	2'10"	7'4"
F235A.0.24	139380	41'2"	25'9"	400	26559	4640	12 - 17	32	5522	8'1"	2'10"	7'4"
F235A.0.25	137138	48'0"	32'3"	400	26559	4640	12 - 17	32	5787	8'1"	3'2"	7'4"
F235AC.0.22*	149651	21'11"	9'6"	400	26559	4640	12 - 17	32	4651	8'0"	2'10"	7'4"
F235AC.0.23*	145239	28'10"	16'0"	400	26559	4640	12 - 17	32	5048	8'0"	2'10"	7'4"
F235AC.0.24	141550	35'11"	22'11"	400	26559	4640	12 - 17	32	5368	8'0"	2'10"	7'4"
F235AC.0.25*	140826	42'7"	29'4"	400	26559	4640	12 - 17	32	5643	8'1"	3'2"	7'4"
F235A.0.23/L212*	142273	16,65	9,25	400	26559	4640	12 - 17	32	6371	8'2"	3'6"	7'10"
F235A.0.23/L213	142273	61'2"	36'8"	400	26559	4640	12 - 17	32	6558	8'2"	3'6"	7'10"
F235A.0.24/L212*	143864	18,70	11,35	400	26559	4640	12 - 17	32	6701	8'2"	3'6"	7'10"
F235A.0.24/L213*	143864	20,75	13,30	400	26559	4640	12 - 17	32	6889	8'2"	3'6"	7'10"
F235A.0.24/L214	143864	77'5"	49'6"	400	26559	4640	12 - 17	32	7032	8'2"	3'6"	7'10"
F235AC.0.23/L212*	145239	15,00	8,40	400	26559	4640	12 - 17	32	6216	8'2"	3'6"	7'10"
F235AC.0.23/L213*	145239	17,00	10,35	400	26559	4640	12 - 17	32	6404	8'2"	3'6"	7'10"

*US / The range of versions available also includes F235AC.0.22 , F235AC.0.23 , F235AC.0.25 , F235A.0.23/L212 , F235A.0.24/L212/L213 , F235AC.0.23/L212/L213 to see the load diagram go to fassitech.com: - FR / La gamme de versions disponibles comprend aussi F235AC.0.22 , F235AC.0.23 , F235AC.0.25 , F235A.0.23/L212 , F235A.0.24/L212/L213 , F235AC.0.23/L212/L213 , pour voir le diagramme de charge consulter le site Internet fassitech.com - ES / La gama de versiones disponibles también incluye F235AC.0.22 , F235AC.0.23 , F235AC.0.25 , F235A.0.23/L212 , F235A.0.24/L212/L213 , F235AC.0.23/L212/L213 , para ver el diagrama de carga visitar el sitio web fassitech.com

												
	Lifting capacity	Standard reach	Hydraulic extension	Rotation	Rotation torque	Working pressure	Pump capacity	Oil tank capacity	Crane weight	Crane width	Installation width	Crane height
	Capacité de levage	Bras standard	Extension hydraulique	Rotation	Couple de rotation	Pression d'utilisation	Débit de la pompe	Capacité du réservoir d'huile	Poids de la grue	Largeur de la grue	Largeur de montage	Hauteur de la grue
	Capacidad de elevación	Brazo standard	Extensión hidráulica	Ángulo de rotación	Potencia de rotación	Presión de trabajo	Capacidad de la bomba	Capacidad depósito aceite	Peso de la grúa	Anchura de la grúa	Anchura de montaje	Altura de la grúa

F235A e-active

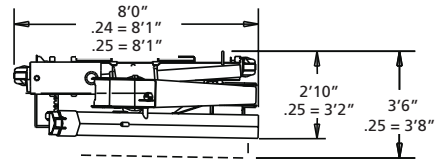
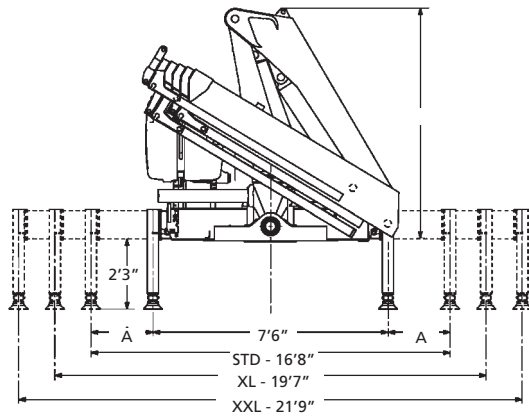

	STD	XL	XXL
A	6'4"	6'0"	7'1"

L SERIE

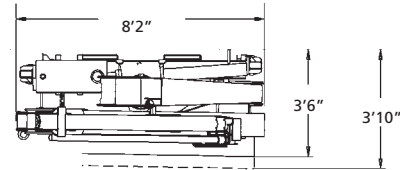
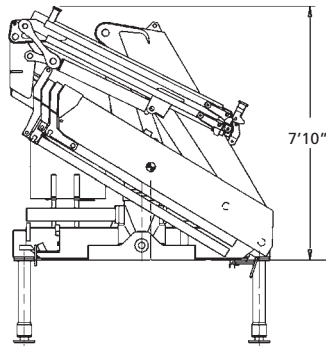

L212	1102 lbs
ML	97 lbs
NL	63 lbs
PL	46 lbs

L213	1278 lbs
NL	63 lbs
PL	46 lbs

L214	1432 lbs
PL	46 lbs

F235A e-active

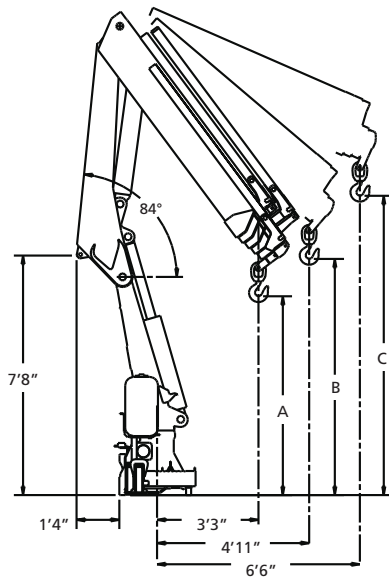

	A	B	C
F235A.0.21	7'7"	9'1"	12'4"
F235A.0.22	7'3"	8'8"	11'5"
F235A.0.23	7'0"	8'4"	10'9"
F235A.0.24	6'8"	7'11"	10'2"
F235A.0.25	6'5"	7'7"	9'8"



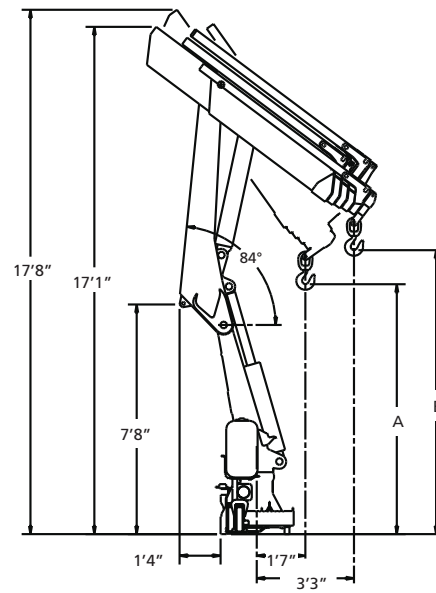









F235AC e-active









































	A	B
F235AC.0.24	7'8"	9'11"

F235A e-dynamic

Technical data

lbs/ft												
	lbs.ft	ft	ft	°	lbs.ft	psi	gpm	gal	lbs	ft	ft	ft
F235A.2.22	146757	27'2"	13'1"	400	24715	4790	12 - 17	32	5445	8'3"	3'0"	7'10"
F235A.2.23	143792	34'5"	20'0"	400	24715	4790	12 - 17	32	5798	8'2"	3'2"	7'10"
F235A.2.24	139380	41'8"	27'0"	400	24715	4790	12 - 17	32	6172	8'3"	3'2"	7'10"
F235A.2.25	137861	48'10"	33'11"	400	24715	4790	12 - 17	32	6547	8'3"	3'2"	7'10"
F235A.2.26	134172	56'1"	40'10"	400	24715	4790	12 - 17	32	6768	8'3"	3'2"	7'10"
F235AC.2.23*	145962	29'10"	17'10"	400	24715	4790	12 - 17	32	5665	8'3"	3'2"	7'10"
F235AC.2.24	142273	37'0"	24'11"	400	24715	4790	12 - 17	32	6040	8'3"	3'2"	7'10"
F235AC.2.25*	141550	44'3"	31'9"	400	24715	4790	12 - 17	32	6393	8'3"	3'2"	7'10"
F235AC.2.26*	138584	51'6"	38'8"	400	24715	4790	12 - 17	32	6657	8'3"	3'2"	7'10"
F235A.2.23/L212*	143792	54'7"	31'7"	400	24715	4790	12 - 17	32	7054	8'3"	3'8"	8'8"
F235A.2.23/L213*	143792	61'2"	37'10"	400	24715	4790	12 - 17	32	7253	8'3"	3'8"	8'8"
F235A.2.23/L214*	143792	67'5"	43'9"	400	24715	4790	12 - 17	32	7363	8'3"	3'8"	8'8"
F235A.2.24/L212*	139380	61'8"	38'6"	400	24715	4790	12 - 17	32	7418	8'3"	3'8"	8'9"
F235A.2.24/L213*	139380	68'2"	44'11"	400	24715	4790	12 - 17	32	7594	8'3"	3'8"	8'9"
F235A.2.24/L214	139380	74'5"	50'10"	400	24715	4790	12 - 17	32	7716	8'3"	3'8"	8'9"
F235A.2.25/L102	137861	69'10"	45'9"	400	24715	4790	12 - 17	32	7341	8'3"	3'8"	8'7"
F235AC.2.24/L212*	142273	57'1"	36'5"	400	33,5	33	45 - 65	120	7286	8'3"	3'8"	8'9"
F235AC.2.24/L213*	142273	63'7"	42'9"	400	33,5	33	45 - 65	120	7462	8'3"	3'8"	8'9"
F235AC.2.24/L214*	142273	69'10"	48'10"	400	33,5	33	45 - 65	120	7583	8'3"	3'8"	8'9"

*US / The range of versions available also includes F235AC.2.23, F235AC.2.25, F235AC.2.26, F235A.2.23/L212/L213/L214, F235A.2.24/L212/L213, F235AC.2.24/L212/L213/L214 to see the load diagram go to fassitech.com: - FR / La gamme de versions disponibles comprend aussi F235AC.2.23, F235AC.2.25, F235AC.2.26, F235A.2.23/L212/L213/L214, F235A.2.24/L212/L213, F235AC.2.24/L212/L213/L214, pour voir le diagramme de charge consulter le site Internet fassitech.com - ES / La gama de versiones disponibles también incluye F235AC.2.23, F235AC.2.25, F235AC.2.26, F235A.2.23/L212/L213/L214, F235A.2.24/L212/L213, F235AC.2.24/L212/L213/L214, para ver el diagrama de carga visitar el sitio web fassitech.com

												
	Lifting capacity	Standard reach	Hydraulic extension	Rotation	Rotation torque	Working pressure	Pump capacity	Oil tank capacity	Crane weight	Crane width	Installation width	Crane height
												
	Capacité de levage	Bras standard	Extension hydraulique	Rotation	Couple de rotation	Pression d'utilisation	Débit de la pompe	Capacité du réservoir d'huile	Poids de la grue	Largeur de la grue	Largeur de montage	Hauteur de la grue
												
	Capacidad de elevación	Brazo standard	Extensión hidráulica	Ángulo de rotación	Potencia de rotación	Presión de trabajo	Capacidad de la bomba	Capacidad depósito aceite	Peso de la grúa	Anchura de la grúa	Anchura de montaje	Altura de la grúa

F235A e-dynamic

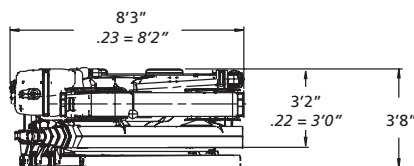
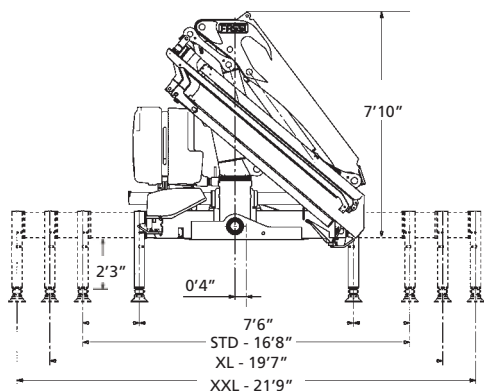

	STD	XL	XXL
A	6'4"	6'0"	7'1"

L SERIE

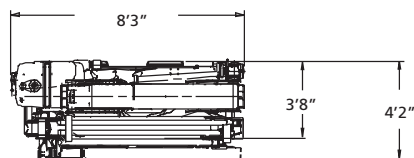
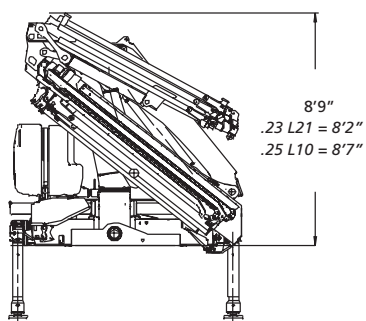

L102	705 lbs	L212	1102 lbs	L213	1278 lbs	L214	1432 lbs
ML	97 lbs	ML	97 lbs	NL	63 lbs	PL	46 lbs
		NL	63 lbs				
		PL	46 lbs				

F235A e-dynamic

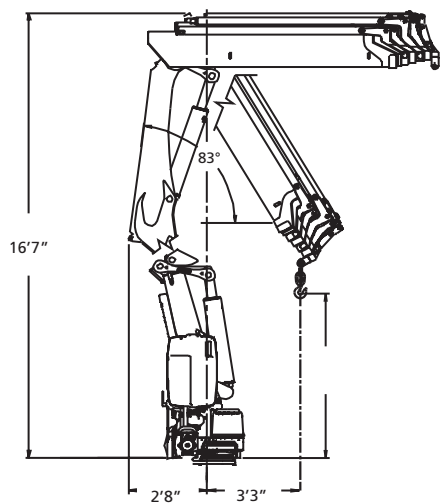

	A
F235A.2.22	7'3"
F235A.2.23	7'4"
F235A.2.24	7'0"
F235A.2.25	6'9"
F235A.2.26	6'5"

F235AC e-dynamic

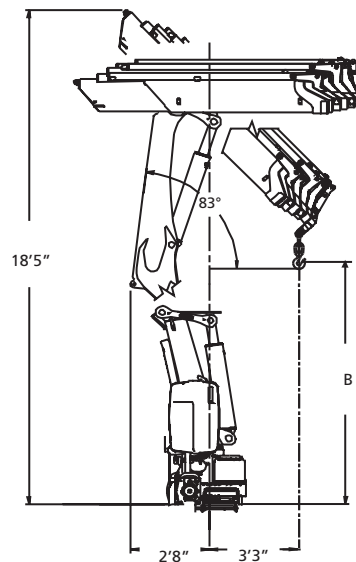

	B
F235AC.2.24	10'0"



US

ELECTRONIC DOCUMENTATION

All documentation related to the "Techno chips" and the crane is available in electronic format. Require all information you may need directly to your Fassi dealer or download them from the internet site: www.fassi.com.

FR

DOCUMENTATION ELECTRONIQUE

Toutes les informations relatives aux "Techno chips" et aux grues sont disponibles sous format électronique. Elles peuvent être demandées aux concessionnaires Fassi ou téléchargées sur le site www.fassi.com.

ES

DOCUMENTACION ELECTRÓNICA

Toda la información relativa a los "techno chips" y a las grúas está disponible en formato electrónico. Se puede solicitar directamente a los concesionarios Fassi, o bien descargarse on line desde la web www.fassi.com.

www.fassi.com

FASSI GRU S.p.A.
Via Roma, 110
24021 Albino (Bergamo) ITALY
Tel- +39 035 776400
Fax +39 035 755020
<http://www.fassi.com>
E-mail: fassi@fassi.com

COMPANY
WITH QUALITY MANAGEMENT
SYSTEM CERTIFIED BY DNV
= ISO 9001 : 2008 =