

Via dei Carmelitani, 2  
 24021 Albino BG  
 tel. ++39 35 776400  
 fax ++39 35 755020  
 www.fassigroup.com  
 fassi@fassigroup.com

LOAD DIAGRAM WITH LIFTING MOMENT LIMITING DEVICE

CAPACITY CHART WITH LIFTING MOMENT LIMITING DEVICE

CRANE TYPE  
**F280SE.22**

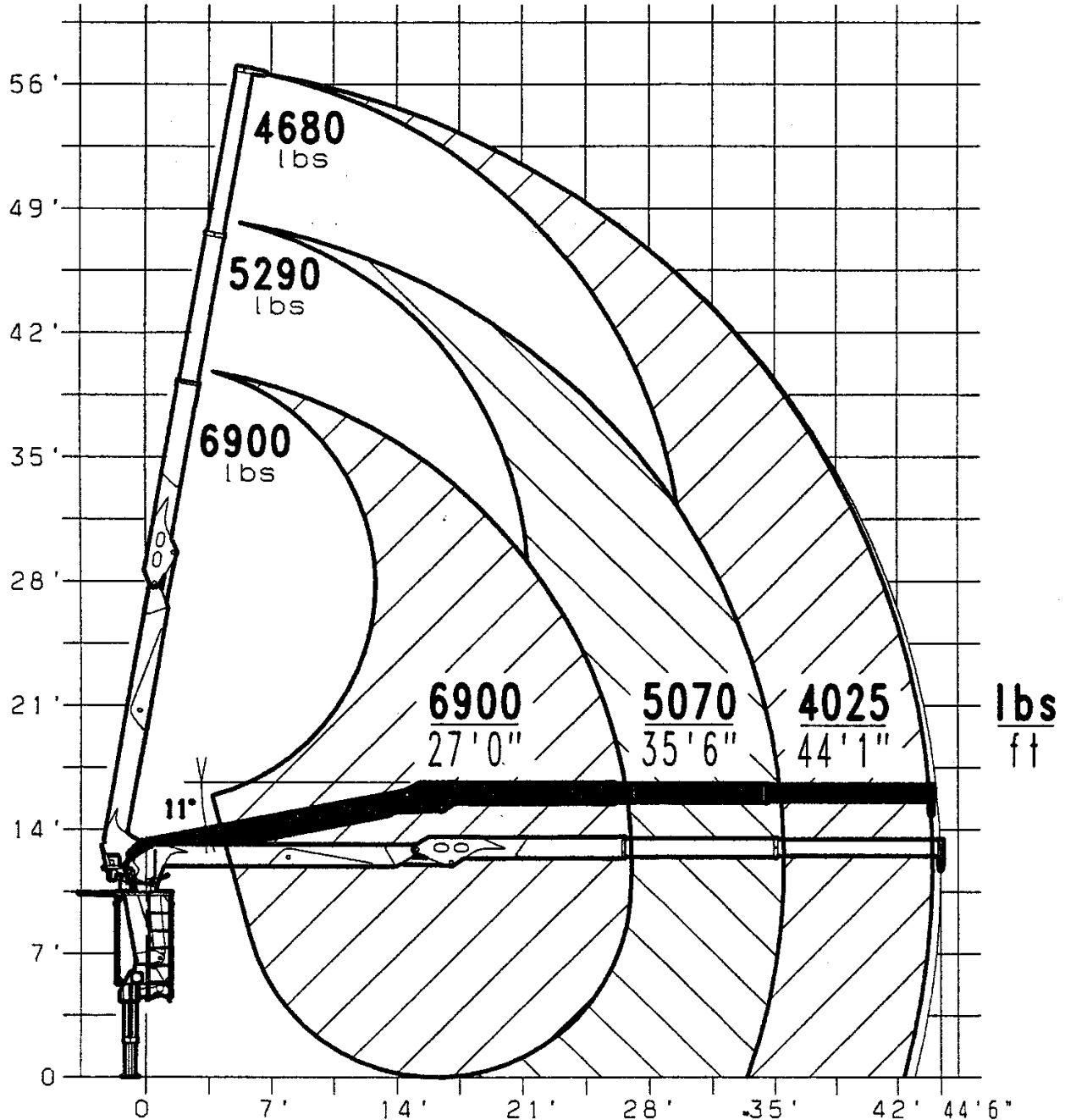

**DO NOT STAY UNDER SUSPENDED LOADS**

THE WEIGHT OF WALLBOARD FORK AND ROTATOR MUST BE DEDUCTED FROM LIFTING CHART.

DE3883